



GOLDER

FIELD SUMMARY REPORT - FINAL

2018 Bruce Head Vessel-based Monitoring Program

Baffinland Iron Mine Corporation

Submitted to:

Baffinland Iron Mine Corporation

2275 Upper Middle Road East - Suite 300
Oakville, Ontario

Submitted by:

Golder Associates Ltd.

2nd floor, 3795 Carey Road, Victoria, British Columbia, V8Z 6T8, Canada

+1 250 881 7372

1663724-089-R-Rev1-11000

30 May 2019

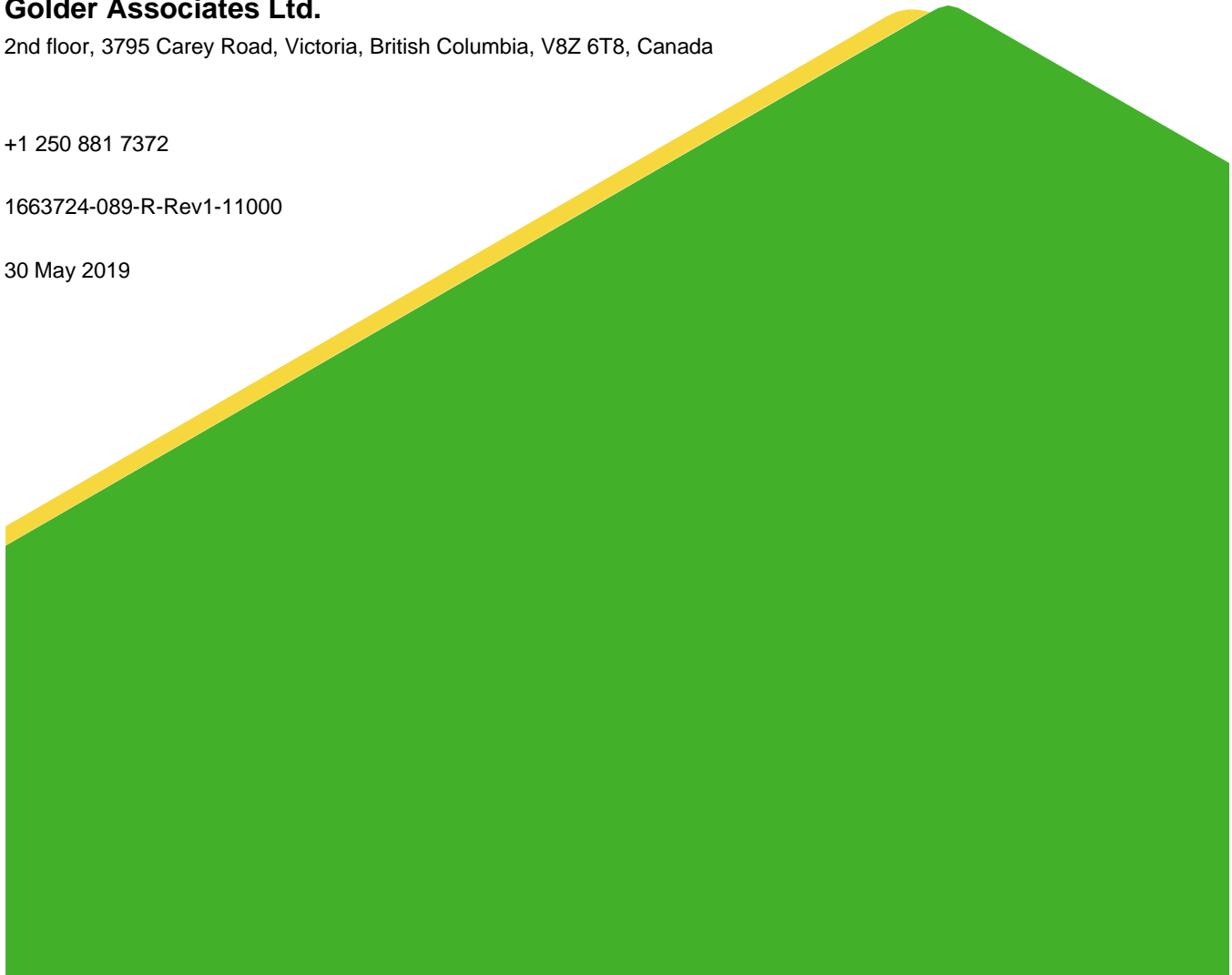

RECORD OF ISSUE

Company	Client Contact	Version	Date Issued	Delivery Method
Baffinland	Megan Lord-Hoyle	A	25 January 2019	e-mail
Baffinland	Megan Lord-Hoyle	0	14 February 2019	e-mail
Baffinland	Megan Lord-Hoyle	0	30 May 2019	e-mail

EXECUTIVE SUMMARY

This report presents a summary of the vessel-based monitoring of narwhal (*Monodon monoceros*) in Milne Inlet, near Bruce Head, during the 2018 Bruce Head Monitoring Program (the Program). The 2018 vessel-based survey represents the sixth consecutive year of environmental effects monitoring undertaken at Bruce Head for the Mary River Project. The 2018 Program was the first monitoring survey to be undertaken from a vessel-based platform. Previous surveys were shore-based from the Bruce Head Peninsula.

The objective of the 2018 Program was to investigate narwhal response to shipping activities along the Northern Shipping Route in Milne Inlet, with the objective of collecting data on narwhal behaviour, group composition, and relative abundance and distribution (RAD).

Vessel-based monitoring of narwhal was conducted from the live-aboard research vessel (RV) *Nuliajuk*, a 60-foot charter vessel. The *Nuliajuk* arrived in Pond Inlet, NU, on 6 August 2018. The survey team consisted of two Golder biologists, one graduate student, and two Inuit participants from Pond Inlet. The size of the research team was limited by vessel accommodations. A two-day data collection and safety training workshop was held in Pond Inlet immediately prior to the start of the Program to train and/or refresh the research team in health and safety protocol, marine mammal survey procedures, and data collection techniques to be implemented during the program.

The Local Study Area (LSA) for the 2018 program was modified significantly compared to previous Bruce Head monitoring programs. Due to the program being exclusively vessel-based, the Survey Area was limited to a 2-kilometre (km) radius semi-circle around the anchored RV *Nuliajuk*. The vessel was anchored approximately 500 m southeast of the Nominal Shipping Route. The RV *Nuliajuk* arrived onsite, in Milne Inlet, on 7 August 2018. Daily monitoring duties commenced on 7 August and consisted of 12-hour monitoring shifts. Visual observations occurred for the first 30 minutes of every hour between 0700 and 1630 hrs. An unmanned aerial vehicle (UAV) survey was added to the 2018 program to enable overhead video monitoring within the defined LSA and compare the quality and quantity of data collected through visual observations with that collected from a bird's-eye view (i.e., the UAV). Applications of the UAV were limited to aerial photography and videography; both high-definition video and high-resolution photographic data were collected from the quadcopter drone (DJI Phantom 4).

Marine observations occurred over an eight-day consecutive period between 7 and 14 August 2018. A minimum of two observers were on deck during data collection periods. The total time spent collecting narwhal sighting data was approximately 176 hours. No narwhal were observed within the Survey Area during the Program from 7 to 14 August 2018. Approximately five individuals were sighted swimming along the cliff face near Bruce Head, on 7 August, at a distance of approximately 5 km. The sightings, however, could not be confirmed. Ringed seal (*Phoca hispida*) were the most common marine mammal sighted within and adjacent to the survey area. Few unconfirmed sightings of bearded seal (*Erignathus barbatus*) were observed at the outer limit of survey area.

STUDY LIMITATIONS

Golder Associates Inc. (Golder) has prepared this document in a manner consistent with that level of care and skill ordinarily exercised by members of the engineering and science professions currently practising under similar conditions in the jurisdiction in which the services are provided, subject to the time limits and physical constraints applicable to this document. No warranty, express or implied, is made.

This document, including all text, data, tables, plans, figures, drawings and other documents contained herein, has been prepared by Golder for the sole benefit of Baffinland Iron Mines Corporation (Baffinland). The Executive Summary was translated into Inuktitut by Rhoda Kayakjuak of Uqausiit Communication Services and provided by Baffinland to Golder. In the event of discrepancies in information or interpretation, the English version shall prevail. This report represents Golder's professional judgement based on the knowledge and information available at the time of completion. Golder is not responsible for any unauthorized use or modification of this document. All third parties relying on this document do so at their own risk.

The factual data, interpretations, suggestions, recommendations and opinions expressed in this document pertain to the specific project, station conditions, design objective, development and purpose described to Golder by Baffinland, and are not applicable to any other project or station location. In order to properly understand the factual data, interpretations, suggestions, recommendations and opinions expressed in this document, reference must be made to the entire document.

This document, including all text, data, tables, plans, figures, drawings and other documents contained herein, as well as all electronic media prepared by Golder are considered its professional work product and shall remain the copyright property of Golder. Baffinland may make copies of the document in such quantities as are reasonably necessary for those parties conducting business specifically related to the subject of this document or in support of or in response to regulatory inquiries and proceedings. Electronic media is susceptible to unauthorized modification, deterioration and incompatibility and therefore no party can rely solely on the electronic media versions of this document.

Table of Contents

1.0 INTRODUCTION	1
1.1 Summary of 2014–2017 Key Findings	1
2.0 METHODS	4
2.1 Survey Vessel	4
2.2 Study Team and Training	4
2.2.1 Community Engagement	4
2.2.2 Survey Team Members	5
2.2.3 Field Training	5
2.3 Study Area	5
2.4 Data Collection	7
2.4.1 Vessel Observations	7
2.4.2 Unmanned Aerial Vehicle Operations	7
3.0 RESULTS	8
3.1 Observational Effort and Environmental Conditions	8
3.2 Relative Abundance and Distribution of Narwhal	8
3.3 General Observations	8
4.0 CONCLUSIONS AND RECOMMENDATIONS	8
5.0 CLOSURE	9
6.0 REFERENCES	10

TABLES

Table 2-1: Inuit Employees Training Details	5
---	---

FIGURES

Figure 2-1: 2018 Survey Platform, the RV <i>Nuliajuk</i>	4
Figure 2-2: 2018 Bruce Head Vessel-based Monitoring Program Survey Area	6

APPENDICES

APPENDIX A

Pond Inlet Inuit Training Documents

APPENDIX B

Bruce Head Vessel-based Marine Mammal Monitoring – Daily Summaries

1.0 INTRODUCTION

This report presents a summary of the vessel-based monitoring of narwhal (*Monodon monoceros*) in Milne Inlet, near Bruce Head, during the 2018 Bruce Head Monitoring Program (the Program). The 2018 vessel-based survey represents the sixth consecutive year of environmental effects monitoring undertaken at Bruce Head for the Mary River Project. The 2018 Program was the first monitoring survey to be undertaken from a vessel-based platform. Previous surveys were shore-based from the Bruce Head Peninsula. The 2018 Program served as a pilot study for the potential integration of future shore-based and vessel-based monitoring programs.

The Mary River Project (Project) is an operating open-pit iron ore mine located in the Qikiqtani Region of North Baffin Island, Nunavut. Baffinland is the owner and operator of the Project. The operating Mine Site is connected to a port at Milne Inlet (Milne Port) via the 100-km long Milne Inlet Tote Road. Future, but yet undeveloped, components of the Project include a South Railway connecting the Mine Site to a future port at Steensby Inlet (Steenbsy Port).

Project Certificate No. 005, amended by the Nunavut Impact Review Board (NIRB) on 27 May 2014, authorizes the Company to mine up to 22.2 million tonnes per annum (Mtpa) of iron ore from Deposit No. 1. Of this 22.2 Mtpa, the Company is currently authorized to transport 18 Mtpa of ore by rail to Steensby Port for year-round shipping through the Southern Shipping Route (via Foxe Basin and Hudson Strait), and 4.2 Mtpa of ore by truck to Milne Port for open water shipping through the Northern Shipping Route using chartered ore carrier vessels. A Production Increase to ship 6.0 Mtpa from Milne Port was approved for 2018 and 2019.

To investigate the response of narwhal to large vessel traffic through Milne Inlet, Baffinland has committed to collecting data on narwhal and shipping activity through a shore-based observation program at an appropriate frequency throughout the Early Revenue Phase (ERP) and for not less than three consecutive years (Project Certificate Conditions No. 99 and 101). The 2018 Bruce Head Monitoring Program (the Program) marks the sixth consecutive year that a team of marine biologists and Inuit participants collected data from the area. This is the second year that the Program was undertaken by Golder Associates (Golder) as it had previously been undertaken by LGL Ltd. (LGL) between 2014 and 2016 (a pilot study survey in 2013). This report summarizes the 2018 Program.

1.1 Summary of 2014–2017 Key Findings

Shore-based monitoring of narwhal was conducted at Bruce Head during the open-water seasons of 2014–2017 (Smith et al. 2015, 2016, 2017; Golder 2018a). The main objective of the monitoring study was to identify potential changes in narwhal distribution, relative abundance, group composition and/or behaviour in Milne Inlet, as observed from Bruce Head, in response to large vessel traffic servicing Milne Port as part of the Mary River Project. Other variables considered in the study included tide, weather, time of day, small vessel movements and hunting activities. A secondary objective of the study was to determine if narwhal exhibited evidence of habituation following repeated exposure to ship traffic over the course of the study period. Shore-based monitoring of narwhal was conducted from an observation platform located on Bruce head, ~215 m above sea level. Survey data for relative abundance and distribution (RAD) were collected in nine distinct geographic strata (27 substrata) extending across Milne Inlet, collectively referred to as the stratified study area (SSA). Group composition and behavioral data were collected within ~1000 m of shore (referred to as the Behavioral Study Area or BSA), as animals transited in front of the platform.

Key findings from the integrated analysis of the 2014–2017 Bruce Head Monitoring Program data (Golder 2018b) include the following:

- Relative abundance and distribution (RAD):
 - The relative abundance of narwhal in the Bruce Head area has remained relatively constant over the four years of sampling (as shown by a lack of significant year effect on counts and fewer occurrences of zero counts in 2017) despite the relative increase in shipping during this period.
 - Model results indicated that vessel direction within Milne Inlet (south- vs northbound vessels) affected the response of narwhal relative to distance from large vessel. Conversely, the direction of vessel relative to the substrata (heading toward or away from substrata) was not a significant predictor of relative abundance.
- Spatial distribution within the SSA – GPS-tagged narwhal were shown to spend the least time in substratum '3' and the most time in substratum '2'. This provides evidence that low RAD counts recorded in substratum '3' are not solely due to reduced observation visibility.
- Group composition and behaviour:
 - Group size — group sizes changed between years, but not in a manner consistent with the increase in vessel traffic between 2014 and 2017. Model results also did not suggest temporary effects of large vessel transits on narwhal group size within the BSA.
 - Group composition — groups with calves/yearlings and groups with tusks were present in the BSA and SSA throughout the four sampling years. Model results indicated no effect of large vessel transits on presence of tusks or calves/yearlings in observed groups in the BSA. For both response variables, group size was the only significant predictor variable identified.
 - Group spread — narwhal were more often observed in tight associations compared to loose associations under both vessel presence and vessel absence scenarios. During passage of a large vessel within 15 km from the BSA, loosely spread groups were more likely to occur when southbound or northbound vessels heading toward the BSA were 2 to 4 km away from the BSA, or when northbound vessels heading away from the BSA were near (≤ 2 km). In addition, the probability of observing a group in a loose spread significantly increased with group size.
 - Group formation — narwhal were usually observed in parallel formation under both vessel presence and vessel absence scenarios. Models indicated no effect of vessel transits on group formation in the BSA (analyzed as presence/absence of non-parallel groups). The probability of observing a non-parallel formation increased significantly with group size.
 - Group direction — narwhal groups were predominantly observed travelling south through the BSA. When northbound large vessels were within 15 km of the BSA, narwhal were most often observed travelling south, regardless of direction of the vessel relative to the BSA. In the presence of southbound vessels, narwhal groups travelled both north and south when the vessel was heading toward the BSA (model predictions were of a predominantly southward traveling direction). When the southbound vessel headed away from the BSA, narwhal groups were observed traveling predominantly north, unless the vessel was within close proximity (≤ 2 km). Narwhal tended to travel south in large groups and north in small groups.

- Travel speed – the majority of narwhal groups travelled at a medium speed, regardless of large vessel presence/absence. The probability of observing slowly-traveling groups increased when large vessels were south of the BSA (regardless of direction of travel and direction relative to the BSA) and in close proximity (≤ 3 km). When vessels were north of the BSA, the probability of observing slowly-traveling groups was low, especially for southbound vessels. The probability of observing slowly-traveling groups decreased with group size.
- Distance from Bruce Head shore - narwhal groups were observed more often at a distance < 300 m of the Bruce Head shore compared to groups > 300 m offshore under both vessel presence and vessel absence scenarios. Offshore groups were detected less frequently with increasing Beaufort scale values, indicating observer impediment with worsening sea state. Model results indicated that narwhal groups tended to be offshore when large vessels were 3 to 6 km away from the BSA, especially when vessels were heading toward the BSA (compared to vessels heading away from the BSA). When vessels were close, the model estimated that narwhal groups were concentrated inshore.
- *Ad libitum* observations collected throughout the four-year study period indicate the following:
 - The majority of narwhal recorded in the SSA during the four-year study period were engaged in travelling behaviour. Other behaviours observed in the SSA included nursing, rubbing, tusking, foraging, and mating. In all years, narwhal calves were commonly observed in the SSA, with observations of nursing behaviour recorded in 2015 (two occasions), 2016 (four occasions) and 2017 (two occasions). On 11 August 2016, the birth of a narwhal calf off Bruce Head was observed. Collectively, these observations lend support to the hypothesis that this part of Milne Inlet is important for calf rearing.
 - Narwhal occur most frequently south of the SSA in the vicinity of Koluktoo Bay and the entrance to Assumption Harbour (Milne Port). A similar distribution of narwhal has been reported during aerial surveys conducted in the Milne Inlet region (Thomas et al. 2015, 2016; Golder 2018c) affirming the importance of Koluktoo Bay as a refuge for narwhal during the open-water season.
 - Responses of narwhal to ore carrier traffic is variable, ranging from ‘no obvious response’ in which animals remain in close proximity to ore carriers as they transit through the SSA, to temporary and localized displacement and related changes in behaviour. However, no overall decrease in the abundance of narwhal in the area was observed.
 - During each survey year, narwhal were observed to respond to shooting by diving and increasing their swim speed. Despite repeatedly being shot at from the same location (i.e. the hunting camp below the observation platform), narwhal were always observed to return to the area at the base of Bruce Head, though the time until they returned was variable.
 - In 2016, narwhal were observed foraging on arctic cod schooling close to the Bruce Head shore on nine days during the first half of August. Mother-calf pairs were observed to engage in foraging behaviours although the majority of these feeding groups did not include calves or yearlings.

2.0 METHODS

The objective of the 2018 Program was to investigate narwhal response to shipping activities along the Northern Shipping Route in Milne Inlet, with the objective of collecting data on narwhal behaviour, group composition, and RAD.

2.1 Survey Vessel

Vessel-based monitoring of narwhal was conducted from the live-aboard research vessel (RV) *Nuliajuk*, a 60-foot charter vessel owned by the Government of Nunavut's Department of Environment (Figure 2-1). The *Nuliajuk* arrived in Pond Inlet, NU, on 6 August 2018; two days later than originally scheduled due to ice delays during mobilization. Golder team members and Inuit researchers occupied the vessel from 6 to 14 August 2018. Golder team members disembarked the vessel at Milne Port on 14 August 2018 and Inuit researchers stayed with the vessel until drop-off at Pond Inlet on 15 August 2018.



Figure 2-1: 2018 Survey Platform, the RV *Nuliajuk*

2.2 Study Team and Training

2.2.1 Community Engagement

Inuit personnel have been integral to the overall success and safe execution of the Bruce Head Monitoring Program since program inception. The technical continuity of this program is greatly reliant on local expertise/knowledge and the continued participation of Pond Inlet community members with respect to study design, program implementation, and field logistics.

2.2.2 Survey Team Members

The survey team consisted of two Golder biologists (Mitch Firman and Andrew Rippington), one graduate student (Sam Sweeney; University of New Brunswick), and two Inuit participants from Pond Inlet (Adrian Ootoova and Johnny Takawgak). The size of the research team was limited by vessel accommodations.

2.2.3 Field Training

A two-day data collection and safety training workshop was held in Pond Inlet immediately prior to the start of the Program to train and/or refresh Inuit researchers in health and safety protocol, marine mammal survey procedures, and data collection techniques to be implemented during the program. Training was provided by Golder's program crew lead (Mitch Firman) and a Golder marine biologist (Andrew Rippington). The training workshop also provided an overall introduction to the Program including the goals, objectives, financial compensation, and reporting outcomes. Table 2-1 provides a list of Inuit trainees.

Training manuals were provided to all study team members at the training session. During the workshop, participants gained hands-on experience using all monitoring equipment (e.g., reticle binoculars), as well as theoretical and practical instruction on data collection, and data entry/upload into field data sheets and the computer-based program specific database.

Health and safety aspects were addressed during the training, including travel management, emergency response, communication planning, and the appropriate use of safety equipment. In-field training continued to be provided to all participants on the survey vessel during the initial few days of the program on an as-needed basis.

Training documentation is provided in Appendix A.

Table 2-1: Inuit Employees Training Details

Name	Position	Date	Length
Adrian Ootoova	Marine Mammal Observer	2 and 3 August 2018	20 hours
Johnny Takawgak	Marine Mammal Observer	2 and 3 August 2018	20 hours
Inook Mucktar	Marine Mammal Observer	3 August 2018	10 hours
Matthew Macpar	Marine Mammal Observer	3 August 2018	10 hours

2.3 Study Area

The Local Study Area (LSA) for the 2018 program was modified significantly compared to previous Bruce Head monitoring programs. Due to the program being exclusively vessel-based, the Survey Area was limited to a 2-km radius semi-circle around the anchored RV *Nuliajuk*. The vessel was anchored approximately 500 m southeast of the Nominal Shipping Route (Figure 2-2).

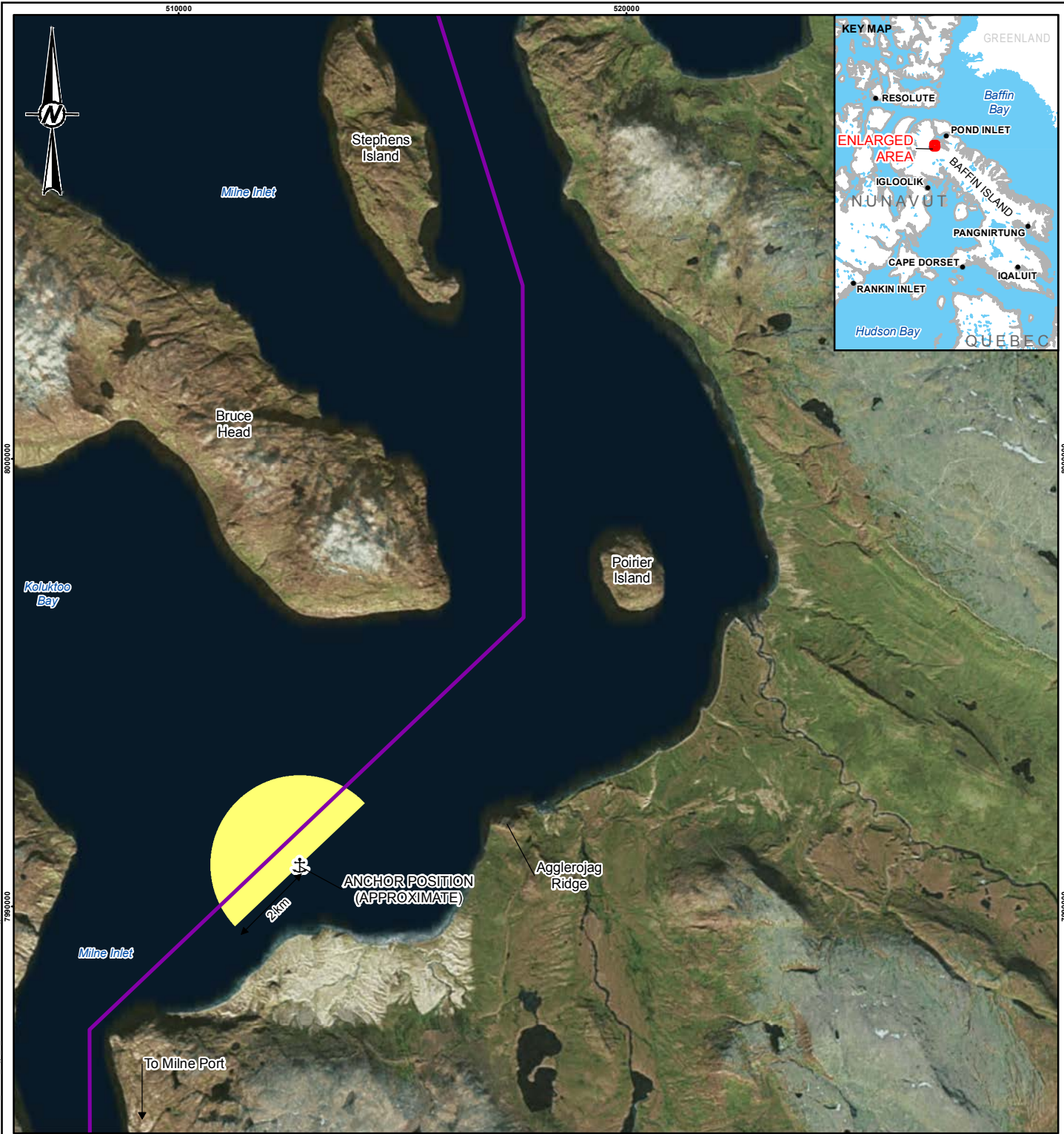

LEGEND

- COMMUNITY
- ⚓ ANCHOR POSITION (APPROXIMATE) - VESSEL-BASED MONITORING
- NOMINAL SHIPPING ROUTE
- SURVEY AREA

1:125,000 KILOMETRES

REFERENCE(S)

SHIPPING ROUTE DATA BY HATCH, JANUARY 25, 2017, RETRIEVED FROM KNIGHT PIESOLD LTD. FULCRUM DATA MANAGEMENT SITE MAY 19, 2017. HYDROGRAPHY, POPULATED PLACE, AND PROVINCIAL BOUNDARY DATA OBTAINED FROM GEOGRATIS, © DEPARTMENT OF NATURAL RESOURCES CANADA. ALL RIGHTS RESERVED. TOPOGRAMA MAPS OBTAINED FROM GEOGRATIS, © DEPARTMENT OF NATURAL RESOURCES CANADA. ALL RIGHTS RESERVED. IMAGERY COPYRIGHT © NULL ESRI AND ITS LICENSORS. SOURCE: TERRACOLOR. USED UNDER LICENSE, ALL RIGHTS RESERVED.

PROJECTION: UTM ZONE 17 DATUM: NAD 83

CLIENT
BAFFINLAND IRON MINES CORPORATION

PROJECT
MARY RIVER PROJECT - BRUCE HEAD MARINE MAMMAL MONITORING PROGRAM 2018

TITLE
BRUCE HEAD VESSEL-BASED MONITORING SURVEY AREA

CONSULTANT	YYYY-MM-DD	2019-05-30
GOLDER	DESIGNED	AR
	PREPARED	AA
	REVIEWED	MF
	APPROVED	PR

PROJECT NO.	CONTROL	REV.	FIGURE
1663724	11000	0	2-2

PATH: I:\2018\1663724\Map\mxd\WHS\fig11000_2014_2017_Report\2018_BruceHeadReport\1663724_11000_fig2_2_BruceHeadReport\1663724_11000_fig2_2_BruceHeadReport.mxd PRINTED ON: 2019-05-30 AT 7:49:29 AM

IF THIS MEASUREMENT DOES NOT MATCH WHAT IS SHOWN, THE SHEET SIZE HAS BEEN MODIFIED FROM: ANSI A 25mm

2.4 Data Collection

A summary of data collection protocols is provided in the subsections below. Details of survey methodology are provided in the Program Training Manual (see Appendix A). Daily summaries of vessel-based monitoring activities and observations from 7 to 14 August 2018 are provided in Appendix B.

2.4.1 Vessel Observations

The 2018 Program was based on a modified version of the 2014–2017 Bruce Head study design and data collection methodology. The RV *Nulijuk* arrived onsite, in Milne Inlet, on 7 August 2018. Daily monitoring duties commenced on 7 August and consisted of 12-hour monitoring shifts. Visual observations occurred for the first 30 minutes of every hour between 0700 and 1630 hrs.

During each daily monitoring shift, observers (minimum two) spent 30 minutes of every hour continuously searching the LSA area and adjacent waters for narwhal activity, as well as collecting data on environmental conditions and anthropogenic activities in Milne Inlet. Observers rotated tasks for effective sharing of observer duties and to reduce potential observer fatigue. Observations were conducted outdoors from atop of the anchored vessel at predetermined viewing locations. Observational data collection viewpoints varied in elevation from approximately 6.0 to 6.8 m above sea level. The observation vessel (RV *Nulijuk*) was located ~500 m southeast of the shipping corridor ~5 km southwest of Bruce Head (see Figure 2-2).

2.4.2 Unmanned Aerial Vehicle Operations

An unmanned aerial vehicle (UAV) survey was added to the 2018 program to enable overhead video monitoring within the defined LSA and compare the quality and quantity of data collected through visual observations with that collected from a bird's-eye view (i.e., the UAV). Applications of the UAV were limited to aerial photography and videography; both high-definition video and high-resolution photographic data were collected from the quadcopter drone (DJI Phantom 4).

Operation of the drone followed Golder's internal protocol that UAVs must not disturb wildlife and maintain a minimum clearance of 100 ft (~30 m) from wildlife regardless of the wildlife's reaction to the UAV.

During drone operations, a safe lateral distance of greater than 300 ft (~90 m) was maintained from vessels. At no time were Golder UAVs flown above or towards other transiting vessels. UAV surveys were conducted in fair weather with good visibility and low winds. Limitations to UAV operation included:

- Operation in fair weather only: maximum wind speed of 15.5 knots (28.7 km/h), no operations in rain and snow or icing conditions, temperatures above -10°C, and good light/visibility.
- Operations were limited to 300 ft (~90 m) above ground level, with cloud ceilings a minimum of 1,000 ft (~300 m), and a minimum of one nautical mile visibility.

3.0 RESULTS

3.1 Observational Effort and Environmental Conditions

Marine observations occurred over an eight-day consecutive period between 7 and 14 August 2018. A minimum of two observers were on deck during data collection periods. The total time spent collecting narwhal sighting data was approximately 176 hours. On the morning of 10 August 2018, the RV *Nuliajuk* was forced to raise anchor and relocate westward into Koluktoo Bay due to high winds and increased sea state. The survey vessel re-anchored at the survey anchor location on the morning of 11 August 2018.

3.2 Relative Abundance and Distribution of Narwhal

No narwhal were observed within the Survey Area during the Program from 7 to 14 August 2018.

3.3 General Observations

In total, approximately 250 seal were observed over the survey period. Ringed seal (*Pusa hispida*) were the most common marine mammal sighted within and adjacent to the survey area. Few sightings of bearded seal (*Erignathus barbatus*) were observed at the outer limit of survey area.

No narwhal were observed within the study area during the Program from 7 to 14 August 2018. Approximately five individuals were sighted swimming along the cliff face near Bruce Head, on 7 August, at a distance of approximately 5 km. The sightings, however, could not be definitively confirmed due to the height of the observer above the waterline compared to sighting distance combining for poor sightability.

4.0 CONCLUSIONS AND RECOMMENDATIONS

No narwhal were observed within the Survey Area during the Program from 7 to 14 August 2018.

During the program ore carriers and shipping vessels were observed to deviate away from the anchored RV *Nuliajuk* and the nominal shipping route. For this reason, combined with physical limitations in long distance sightability from a vessel, Golder recommends shore-based monitoring in subsequent survey years.

5.0 CLOSURE

We trust the information contained in this report is sufficient for your present needs. Should you have additional questions related to the monitoring program, please do not hesitate to contact the undersigned.

Golder Associates Ltd.



Andrew Rippington, RBTech
Biologist



Patrick Abgrall, PhD
Senior Marine Scientist



Iain Jones, MSc, RP Bio
Associate, Senior Wildlife Ecologist

AR/PA/IJ/asd

Golder and the G logo are trademarks of Golder Associates Corporation

o:\final2016\3 proj\1663724 baff_marinemammalsurvey_ont\1663724-089-r-rev1\1663724-089-r-rev1-2018 bh_filed summary report-30may_19.docx

6.0 REFERENCES

- Golder. 2018a. 2017 Bruce Head shore-based monitoring program. Final Golder Report No. 1663724-041-R-Rev0. Prepared by Golder Associates Ltd., Victoria, BC for Baffinland Iron Mines Corporation, Oakville, Ontario. 87 p. + appendices.
- Golder. 2018b. 2017 Bruce Head shore-based monitoring program – 2014-2017 Integrated Report. Final Golder Report No. 1663724-081-R-Rev0-12000. Prepared by Golder Associates Ltd., Victoria, BC for Baffinland Iron Mines Corporation, Oakville, Ontario. 103 p.
- Golder. 2018c. 2016 Marine Mammal Aerial Photography Survey – Milne Inlet and Eclipse Sound. Mary River Project – Phase 2 Proposal. 1663724-036-R-Rev1. 19 June 2018.
- Smith HR, Brandon JR, Abgrall P, Fitzgerald M, Elliott RE, and Moulton VD. 2015. Shore-based monitoring of narwhal and vessels at Bruce Head, Milne Inlet, 30 July - 8 September 2014. Final LGL Report No. FA0013-2. Prepared by LGL Limited, King City, Ontario for Baffinland Iron Mines Corporation, Oakville, Ontario. 73 p. + appendices.
- Smith HR, Raborn S, Fitzgerald M, and Moulton VD. 2016. Shore-based monitoring of narwhal and vessels at Bruce Head, Milne Inlet, 29 July – 5 September 2015. LGL Report No. FA0044-1. Prepared by LGL Limited, King City, Ontario for Baffinland Iron Mines Corporation, Oakville, Ontario. 73 p. + appendices.
- Smith HR, Moulton VD, Raborn S, Abgrall P, Elliott RE, and Fitzgerald M. 2017. Shore-based monitoring of narwhal and vessels at Bruce Head, Milne Inlet, 2016. LGL Report No. FA0089-1. Prepared by LGL Limited, King City, Ontario for Baffinland Iron Mines Corporation, Oakville, Ontario. 87 p. + appendices.
- Thomas TA, Raborn S, Elliott RE, and Moulton VD. 2015. Marine mammal aerial surveys in Eclipse Sound, Milne Inlet, Navy Board Inlet, and Pond Inlet, 1 August – 22 October 2014. Final LGL Report No. FA0024-2. Prepared by LGL Limited, King City, ON for Baffinland Iron Mines Corporation, Oakville, ON. 70 p.
- Thomas TA, Raborn S, Elliott RE, and Moulton VD. 2016. Marine mammal aerial surveys in Eclipse Sound, Milne Inlet and Pond Inlet, 1 August – 17 September 2015. LGL Report No. FA0059-3. Prepared by LGL Limited, King City, ON for Baffinland Iron Mines Corporation, Oakville, ON. 76 p. + appendices.

APPENDIX A

Pond Inlet Inuit Training Documents



REPORT

Bruce Head - Vessel-based Marine Mammal Monitoring Program

Training Manual

1663724-077-R-Rev0

31 July 2018

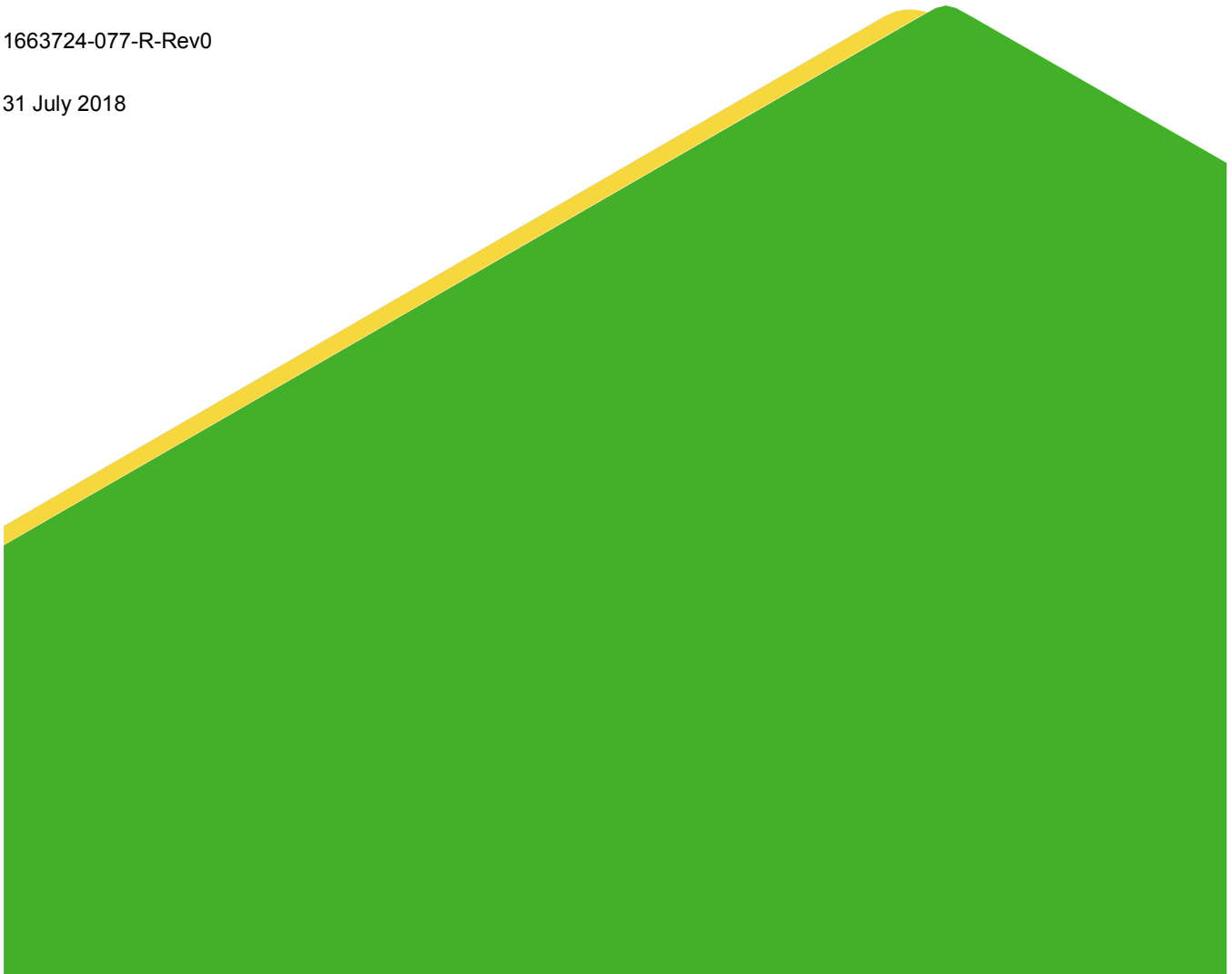

Table of Contents

1.0 INTRODUCTION	1
2.0 OBJECTIVES OF THE SHIP-BASED OBSERVER (BRUCE HEAD) PROGRAM	1
3.0 LIFE AT SEA	1
3.1 What to Bring	2
3.2 Vessel	2
3.3 Health and Safety	5
4.0 TRAINING GOALS	6
5.0 MARINE MAMMAL SURVEY	6
5.1 Introduction to Program Design	6
5.2 Field Schedule	6
5.3 Observation Platform	10
5.4 Survey Area	10
5.5 Equipment	10
5.6 Visual Observation	12
5.6.1 Roles and Responsibilities	13
5.6.2 Protocol	14
5.7 UAV	20
5.7.1 Roles and Responsibilities	20
5.7.2 Protocol	21
5.8 Observing Techniques	21
5.9 Estimating Distances	22
5.10 Detection Cues	25
5.11 Environmental Variables	27
5.12 Recording Data	34

TABLES

Table 1: Schedule.....	7
Table 2: Roles and Responsibilities	13
Table 3: Minimum data recorded for each marine mammal sighting	15
Table 5: Life Stages of Narwhal	17
Table 6: Group Formation Categories	18
Table 7: Behavioral data (primary and secondary) to be recorded	18
Table 8: Vessel and anthropogenic data to be recorded.....	19
Table 9: Roles and Responsibilities	20
Table 10: Distance Table Example.....	23
Table 11: Beaufort Scale for Wind Force	28
Table 12: Sea States Categories and Corresponding Descriptions in relation to Beaufort Wind Force	29
Table 13: Sun Glare.....	32

FIGURES

Figure 1: Study Areas for Bruce Head Program - 2018	4
Figure 2: Degrees in Relation to the Vessel	10
Figure 3: S and U Scanning Techniques to be used during Marine Mammal Observing	22
Figure 4: Calculate the Distance to the Marine Mammal	24
Figure 5: Splash.....	25
Figure 6: Footprint from Marine Mammal	26
Figure 7: Birds on the Water with Whale	26
Figure 8: Toothed whale blow (left) versus baleen whale blow (right)	27

APPENDICES

APPENDIX A

Vessel Safety Orientation

APPENDIX B

Species Identification

APPENDIX C

Golder Guideline and Directive - UAV

APPENDIX D

Hard Copy Datasheets

1.0 INTRODUCTION

The Bruce Head vessel-based marine mammal monitoring program (Bruce Head Program) represents one of several programs that were developed in order to support the Mary River Project (the Project). The Bruce Head Program is part of the Marine Environmental Effects Monitoring Program (MEEMP) for marine mammals in accordance with Project Certificate terms and conditions issued for the Project. This manual was developed by experienced marine mammal observers (MMOs) to train other biologists and non-biologists who may or may not have MMO experience to support the objectives of the MEEMP. An Unmanned Aerial Vehicle (UAV) will also be used by a trained pilot to compliment MMO activities. You may be asked to assist with UAV operations as an observer as well as MMO activities.

A MMO is a person with training in marine mammal survey techniques. These techniques include spotting and identifying marine mammals, estimating distances to sightings, determining relative location of sightings and their movement with respect to the vessel, and recording environmental variables. This training may also serve as a refresher course for experienced MMOs. A UAV pilot is someone with training in flying and operating Golder's owned UAV. A UAV observer can be anyone who is able to assist the UAV pilot in observing the UAV while the pilot flies the UAV offshore.

This Bruce Head Program manual will cover:

- objectives of the Bruce Head Program
- life at sea
- training goals
- marine mammal survey protocol
- UAV survey protocol



2.0 OBJECTIVES OF THE SHIP-BASED OBSERVER (BRUCE HEAD) PROGRAM

The main role of the MMO on a vessel is to continuously scan the water around the vessel and actively look for marine mammals.

- To document all marine mammal observations and behaviours while onboard the vessel.
- To document any marine mammal vessel interactions or incidents of concern related to vessel activities.

3.0 LIFE AT SEA

Working at sea for long periods of time is an exciting adventure, but it can also be challenging. Your experience on a vessel will depend a lot on your attitude and what you make of the experience. It is usually a great opportunity to explore areas not often seen by others, or to view a familiar area through a different point of view, and to develop relationships in the close community on board a vessel.

Since a ship is a confined environment with limited space shared by a number of people, some rules and procedures are often needed. The following section will introduce you to the conditions of working at sea.

3.1 What to Bring

Remember to bring copies of all your important documents and certificates. You are required to bring:

- Valid photo identification and other important documents and certificates.
- Important medication (i.e., Epipen, seasickness tablets etc.). If you take regular medications, bring enough to last the entire trip with enough to last an extra week, just in case.
- Personal toiletries.
- Outdoor clothing to wear on deck.
- Steel toe footwear are required on outside decks.
- Indoor footwear to wear in the vessel where you will spend most of your time.
- Flip-flops for wearing in the shower (optional)
- Pajamas or clothes to wear while sleeping and sharing bunk rooms.
- Camera (optional)
- Sunglasses (polarized are better), sunscreen.
- Water bottle (optional).
- Personal entertainment. Since entertainment can be limited, it is strongly recommended that you bring items such as books, music, cards, games or other hobbies to keep yourself busy during your spare time. This can go a long way towards keeping you happy during your stay.
- Don't count on cell phone service or internet. There will be a satellite phone to use for emergencies.

3.2 Vessel

The vessel that will be used for the Bruce Head project is the Canadian multi-purpose fisheries research vessel the FRV *Nulijuk* (Photo 1). It is approximately 19.5 m by 10 m and can accommodate up to 9 crew. The vessel will be stationary during the program while anchored in the waters below Bruce Head (Figure 1).

Its crew are Transport Canada certified to meet government safety requirements. This includes:

- Transport Canada safety inspections
- marine safety equipment available onboard
- marine emergency procedures (e.g., man overboard), and evacuation procedures
- crew certified in vessel operation, Marine First Aid, and Marine Emergency Duties



Photo 1: FRV Nuliajuk

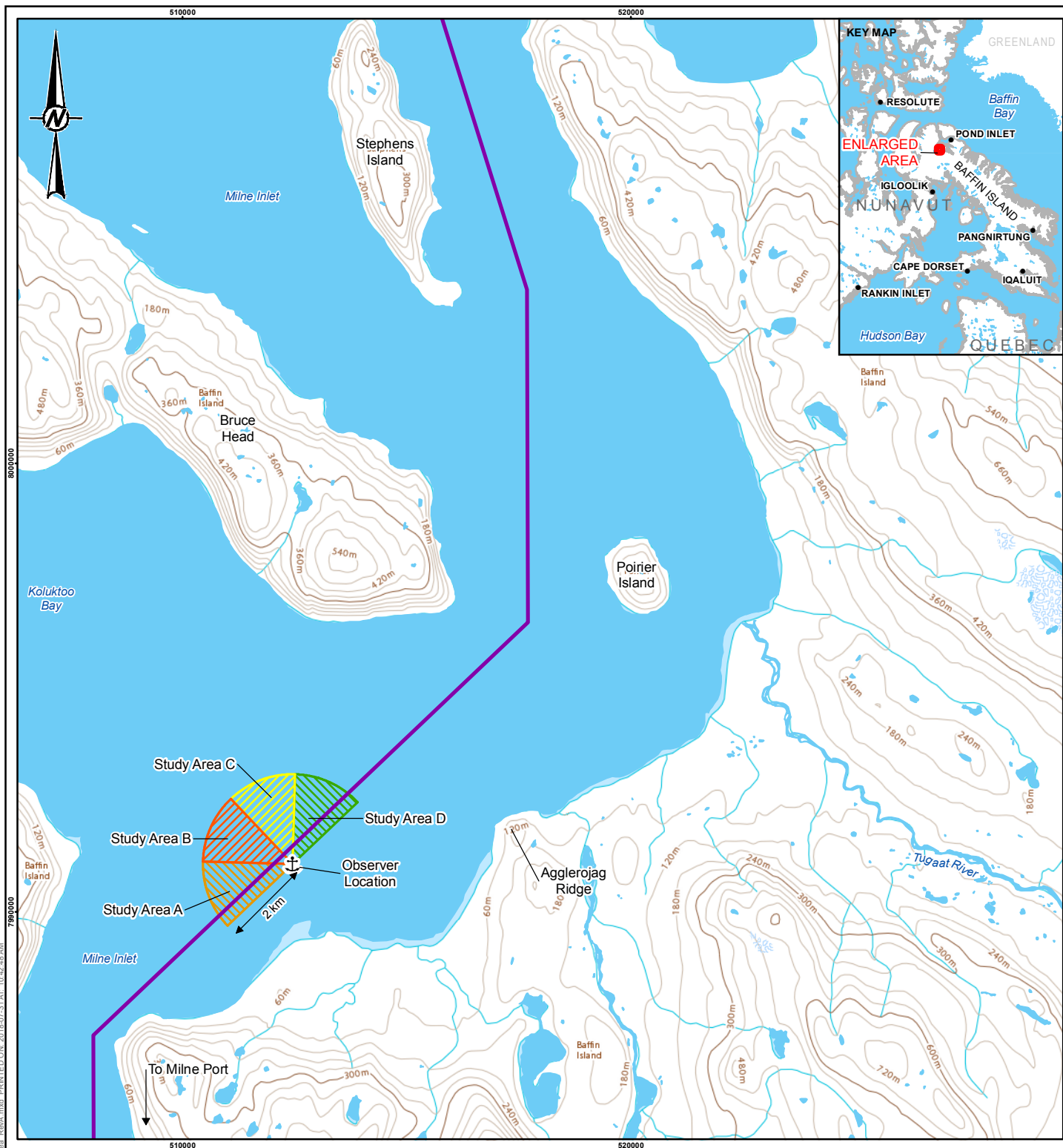

LEGEND

- COMMUNITY
- ⚓ OBSERVER LOCATION (BOAT)
- APPROXIMATE SHIPPING ROUTE
- ▨ STUDY AREA A
- ▨ STUDY AREA B
- ▨ STUDY AREA C
- ▨ STUDY AREA D
- WATERBODY

DRAFT

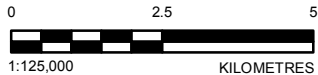

REFERENCE(S)

SHIPPING ROUTE DATA BY HATCH, JANUARY 25, 2017. RETRIEVED FROM KNIGHT PIESOLD LTD. FULCRUM DATA MANAGEMENT SITE MAY 19, 2017. HYDROGRAPHY, POPULATED PLACE, AND PROVINCIAL BOUNDARY DATA OBTAINED FROM GEOGRATIS. © DEPARTMENT OF NATURAL RESOURCES CANADA. ALL RIGHTS RESERVED. TOPORAMA MAPS OBTAINED FROM GEOGRATIS. © DEPARTMENT OF NATURAL RESOURCES CANADA. ALL RIGHTS RESERVED. PROJECTION: UTM ZONE 17 DATUM: NAD 83

CLIENT
BAFFINLAND IRON MINES CORPORATION

PROJECT
MARY RIVER PROJECT - BRUCE HEAD MARINE MAMMAL MONITORING PROGRAM 2018

TITLE
STUDY AREAS FOR BRUCE HEAD PROGRAM - 2018

CONSULTANT	YYYY-MM-DD	2018-07-31
	DESIGNED	KZ
	PREPARED	AA
	REVIEWED	
	APPROVED	

PROJECT NO.	CONTROL	REV.	FIGURE
1663724	11000	A	1

PATH: I:\2018\1663724\MapInfo\MapInfo\1663724_11000_Fin1_BruceHead_20180731.mxd PRINTED ON: 2018-07-31 AT: 10:42:48 AM

IF THIS MEASUREMENT DOES NOT MATCH WHAT IS SHOWN, THE SHEET SIZE HAS BEEN MODIFIED FROM: ANSIA 25mm

3.3 Health and Safety

Vessel specific health and safety to consider while onboard the vessel will be covered once you board the vessel. This will include:

- emergency equipment and supplies
- emergency drills (man overboard, spills, abandon ship)
- location of medic/nurse station
- restricted areas
- smoking areas and non-smoking areas
- drug and alcohol policies
- areas where specific personal protective equipment (PPE) is required
- how and when to use an immersion suit and SOLAS life vest (provided by the vessel)
- all survey crew will partake in a Vessel Safety Orientation before the start of the Bruce Head Program. The details of this training are provided in APPENDIX A.



Additional health and safety requirements are covered in the Bruce Head program-specific Health, Safety, and Environment (HSE) Plan which will be reviewed prior to the start of any Bruce Head Program related work. A major component of the HSE Plan is the identification of potential health and safety hazards associated with the Bruce Head Program including environmental conditions and MMO activities and the implementation of the controls necessary to minimize the risk to people. The program-specific HSE Plan is based on the assessment of previous worksites and

similar activities, and is a dynamic document that can be modified if things change during the Bruce Head Program. The HSE plan will cover the following information:

- personnel contact information
- emergency contact information
- Safe Work Practices and Procedures
- toolbox meetings (to be completed at the start of every day)
- incident reporting

While working at sea there is the potential to become seasick. This can affect your ability to continue to observe for marine mammals. It is recommended that if you are unsure about whether or not you will get seasick that you plan to bring enough seasickness medication to last you the entire program.

4.0 TRAINING GOALS

From this manual; you will learn:

- field schedule and what is expected of you
- position on the vessel while observing
- observation techniques
- how to use the equipment
- how to estimate distances
- how to record data
- how to spot and identify marine mammals

5.0 MARINE MAMMAL SURVEY

5.1 Introduction to Program Design

The Bruce Head Program will consist of two MMOs, two UAV pilots (one will also act as the Golder Field Lead), a UAV observer and two data recorders. The MMOs and UAV team will collect complementary information.

The main purpose of the program is to compare the following data collected by the MMOs and UAV. It is important that the data collected by UAV is not communicated to the MMOs during an active survey. This will be discussed in more detail below.

The following information will be collected during the program:

- 1) visual observations of marine mammal sightings
- 2) UAV video observations of marine mammal sightings
- 3) vessel characterization
- 4) environmental conditions

5.2 Field Schedule

MMOs will rotate every 2 hours which will be called the “watch period”. Within the watch period, MMOs will conduct 30 minute surveys every hour (e.g., MMOs will actively survey for 1 hour every watch period, Table 1). The UAV pilot, observer and data recorder will be required to be on the monkey bridge with the MMO team during all survey periods (Table 1). Breaks will be scheduled around meals times. Surveys will occur during daylight hours from approximately 06:00 to 22:00 EST depending on light availability and time of year. Each field team member will not exceed 10 hours of observations per day.

The Golder Field Lead will be responsible for conducting daily toolbox meetings, reviewing data quality and will be available to mentor the MMOs during active watch periods. The data recorder will collect all data observed by the MMOs and drone pilot.

Table 1: Schedule

24 Hour Clock (EST)	12 Hour Clock (EST)	Watch #	MMO 1	MMO 2	UAV Pilot	UAV Observer	Data Recorder 1	Data Recorder 2	Comments
06:00-06:30	06:00-06:30	Watch 1	Survey	Break/ Breakfast	Watch 1	Watch 1	Survey	Break/ Breakfast	Toolbox Meeting
06:30-07:00	06:30-07:00	Watch 1	Data Review	Break	Break	Break	Data Review	Break	
07:00-07:30	07:00-07:30	Watch 1	Survey	Break	Watch 1	Watch 1	Survey	Break	
07:30-08:00	07:30-08:00	Watch 1	Data Review	Break	Break/ Breakfast	Break/ Breakfast	Data Review	Break	
08:00-08:30	08:00-08:30	Watch 2	Break/ Breakfast	Survey	Watch 2	Watch 2	Break/ Breakfast	Survey	
08:30-09:00	08:30-09:00	Watch 2	Break	Data Review	Break	Break	Break	Data Review	
09:00-09:30	09:00-09:30	Watch 2	Break	Survey	Watch 2	Watch 2	Break	Survey	
09:30-10:00	09:30-10:00	Watch 2	Break	Data Review	Break	Break	Break	Data Review	
10:00-10:30	10:00-10:30	Watch 3	Survey	Break	Watch 3	Watch 3	Survey	Break	
10:30-11:00	10:30-11:00	Watch 3	Data Review	Break	Break	Break	Data Review	Break	
11:00-11:30	11:00-11:30	Watch 3	Survey	Break	Watch 3	Watch 3	Survey	Break	
11:30-12:00	11:30-12:00	Watch 3	Data Review	Break/ Lunch	Break/ Lunch	Break/ Lunch	Data Review	Break/ Lunch	
12:00-12:30	12:00-12:30	Watch 4	Break	Survey	Watch 4	Watch 4	Break	Survey	
12:30-13:00	12:30-1:00	Watch 4	Break	Data Review	Break	Break	Break	Data Review	

24 Hour Clock (EST)	12 Hour Clock (EST)	Watch #	MMO 1	MMO 2	UAV Pilot	UAV Observer	Data Recorder 1	Data Recorder 2	Comments
13:00-13:30	1:00-1:30	Watch 4	Break	Survey	Watch 4	Watch 4	Break	Survey	
13:30-14:00	1:30-2:00	Watch 4	Break	Data Review	Break	Break	Break	Data Review	
14:00-14:30	2:00-2:30	Watch 5	Survey	Break	Watch 5	Watch 5	Survey	Break	
14:30-15:00	2:30-3:00	Watch 5	Data Review	Break	Break	Break	Data Review	Break	
15:00-15:30	3:00-3:30	Watch 5	Survey	Break	Watch 5	Watch 5	Survey	Break	
15:30-16:00	3:30-4:00	Watch 5	Data Review	Break	Break/ Dinner	Break/ Dinner	Data Review	Break	
16:00-16:30	4:00-4:30	Watch 6	Break/ Dinner	Survey	Watch 6	Watch 6	Break/ Dinner	Survey	
16:30-17:00	4:30-5:00	Watch 6	Break	Data Review	Break	Break	Break	Data Review	
17:00-17:30	5:00-5:30	Watch 6	Break	Survey	Watch 6	Watch 6	Break	Survey	
17:30-18:00	5:30-6:00	Watch 6	Break	Data Review	Break	Break	Break	Data Review	
18:00-18:30	6:00-6:30	Watch 7	Survey	Break/ Dinner	Watch 7	Watch 7	Survey	Break/ Dinner	
18:30-19:00	6:30-7:00	Watch 7	Data Review	Break	Break	Break	Data Review	Break	
19:00-19:30	7:00-7:30	Watch 7	Survey	Break	Watch 7	Watch 7	Survey	Break	
19:30-20:00	7:30-8:00	Watch 7	Data Review	Break	Break	Break	Data Review	Break	
20:00-20:30	8:00-8:30	Watch 8	Break	Survey	Watch 8	Watch 8	Break	Survey	
20:30-21:00	8:30-9:00	Watch 8	Break	Data Review	Break	Break	Break	Data Review	

24 Hour Clock (EST)	12 Hour Clock (EST)	Watch #	MMO 1	MMO 2	UAV Pilot	UAV Observer	Data Recorder 1	Data Recorder 2	Comments
21:00-21:30	9:00-9:30	Watch 8	Break	Survey	Watch 8	Watch 8	Break	Survey	
21:30-22:00	9:30-10:00	Watch 8	Break	Data Review	Break	Break	Break	Data Review	Final Data Review Daily/ Weekly Reporting

5.3 Observation Platform

All MMOs and UAV pilots/observers will be stationed on the highest point on the vessel, the monkey bridge. This is located outside the vessel therefore it is important to bring warm clothing for working out on the deck.

5.4 Survey Area

The *FRV Nuliajuk* will be anchored within the shipping route of the Mary River Project south of the Bruce Head peninsula in Milne Inlet. The survey area is a semi-circle that extends 2 km from the observation platform (anchored survey vessel) overlapping with the shipping route (Figure 1). The semi-circle extends from 270 degrees on the port to 90 degrees on the starboard, relative to the center trackline of the survey vessel (0 degrees) (Figure 2). The survey area has been further divided into 4 equal study areas (A, B, C, and D) in a radial design out from the observer platform in order to help capture minimal survey effort time needed to conduct each Visual Observation survey (Section 5.6 for further details).

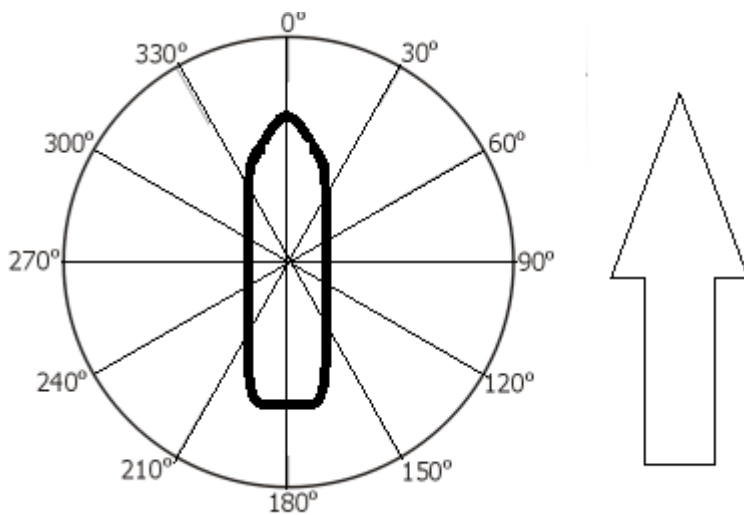

Figure 2: Degrees in Relation to the Vessel

5.5 Equipment

Binoculars

Typical binoculars increase objects 7 to 10 times (i.e., 7x or 10x). 7 X 50 reticle binoculars (used when estimating distances) will be used to identify marine mammals in the survey area.

It is suggested to regularly clean the binocular eye pieces with an alcohol based antiseptic cloth in between sharing binocular with other individuals. This prevents to spread of eye infections which are usually highly contagious. Additionally, if they come in contact with ocean water, rinse them with fresh water and let them dry. Use a soft cloth to clean the lenses as they are prone to scratches and some have protective coats that can wear out.

Reticle Binoculars



Reticle binoculars have a scale built inside the lenses called a reticle which is used to estimate distances of objects. This will be discussed in greater detail below.

Pelorus

A pelorus is a marine instrument used to take radial angle (or a bearing) towards an object so that its location, along with distance to the object, can be projected out from the observer platform. The radial angle is based on the compass degrees ranging from 0 to 360 degrees. The MMO will use this instrument to take a bearing towards a sighting (marine mammal or vessel) by lining up the forward and aft sighting line to the marine mammal's position, and call out the degree reading on the compass rose.



Clinometer



A clinometer is an instrument used for measuring angles of slope with respect to gravity. The MMO will use this to measure an angle of slope to a sighting (marine mammal or vessel). The slope will be used after the field work to help with calculating distance to the sighting.

UAV

Unmanned Aerial Vehicles (i.e., UAV) is an aircraft with no pilot on board. They are commonly known as drones. Golder will deploy DJI Phantom 4 UAVs (drones) during the Bruce Head program surveys to ground-truth visual observations made from the research vessel. The drones have a ground-based pilot who controls the drone from a hand-held remote control from the vessel, however, they can be autonomous if needed.

The body of the drone is approximately 10" tall and 16" across. It weighs about three pounds and is self-contained. Drone positioning is aided by internal GPS software. We will be operating the unit in dry conditions with winds up to approximately 30 km/hr. Drone surveys will occur up to approximately two kilometres from the vessel. The drone has a Return-To-Home function if communications between the pilot and unit become interrupted. Each flight will last approximately 20 minutes depending upon weather conditions.

Laptop with Access database

Data will be entered on a laptop computer with an Access®-based database application or hard copy data sheets outlined below. The database is programmed with data forms (drop-down menus) and data entry fields that are specific to the type of data we are collecting. The data that will be collected in the databased is discussed in more detail below.

Garmin GPS

The Garmin GPSs will be used to record tracks throughout the survey to keep track of any drifting of the vessel and record waypoints when:

- a sighting is made (marine mammal, other vessel)
- the start and end of a watch period
- the environmental variables change

The GPSs should be turned on at the start of the first watch. To turn on the GPS hold the “ON” button located on the top of the device. It may take a few minutes for the device to acquire satellites. The GPSs will be connected to external antennae in order for them to be able to acquire a signal. To take a waypoint press the “MARK” button. A waypoint number will come up on the screen which you will then record in the database.

The MMO should check the GPS regularly during his/her shift to ensure that it has not lost signal and is working properly. It is recommended to change batteries at the earliest warning signal that the batteries are low to ensure data is continuously collected.

Hard Copy Data Sheets

Printed forms of observation data will be available in paper form to be used when observing away from the data recording laptop, or as backup. These forms will collect the same type of data as the Access-based database application.

5.6 Visual Observation

The main objective of the MMOs is to collect visual observations of narwhals in study areas A through D. This includes the following data:

- Number of individuals
- Group composition
- Behaviour

As possible, MMOs will also collect information on other species of marine mammals and vessels in the study area and environmental conditions. APPENDIX B provides information on how to identify other species that may be present in the area. MMOs will relay the information to the Data Recorder.

Details regarding the visual observation protocol are outline below:

- Visual observation surveys are to be undertaken at the start of each watch period and every hour, during the maximum 10-hr observation period.

- Visual observation surveys are to be conducted simultaneously as UAV observation surveys, and the MMO's will work in conjunction with the data recorder and the UAV observer in order to communicate sightings between the two teams.
- Information regarding number of individuals, group composition and behaviour should not be shared between the MMO and UAV teams.
- Visual observation surveys are to be undertaken continuously upon visual detection of large vessels prior to entering the survey area and for the full duration that the vessel is present within the survey area. A final survey is to be made once the large vessel has left the survey area.
- If at the end of a 30 minute survey there are still many animals within the survey area the survey will continue until the animals have left the survey area.

5.6.1 Roles and Responsibilities

Table 2 outlines the Visual Observation – MMO roles and responsibilities as well as what equipment each role will need during the survey.

Table 2: Roles and Responsibilities

Team Role	Responsibility	Equipment
MMO #1, 2 and 3	<ul style="list-style-type: none"> ■ Count all visible marine mammals within each study area ■ Note group size and direction of travel ■ Communicate all sightings to the data recorder and UAV pilot ■ Report glare and sightability within each study area ■ Provide additional Group Composition and Behavioural Data on sightings when possible. ■ Record the presence of all small and large vessels and specify general direction of travel within the survey area. ■ Take multiple sightings of the vessel as it passes through the survey area (take radial angle and distance to the vessel). ■ Record all vessel traffic data as well as hunting activity throughout the observation period, the associated time, and the target species whenever possible. 	7 X 50 binoculars
Data Recorder 1 and 2	<ul style="list-style-type: none"> ■ Record all information received from the MMOs in the database or data sheets. 	Database or Data sheets ²

² Data Sheets: Visual Observations – Marine Mammals

Team Role	Responsibility	Equipment
	<ul style="list-style-type: none"> ■ Document the time stamp when the MMO surveys begins and ends ■ All times should be recorded using UTC¹ ■ Communicate completion of each Visual Observation Survey to the UAV pilot 	

5.6.2 Protocol

The MMO survey protocols to be used will follow Mann (1999³). MMOs will scan each study area (for example Area A) for a minimum of 7.5 minutes (for a total survey time of 30 minutes) and identify all marine mammal groups⁴ (including a solitary narwhal which would be considered a group of 1) within the study area before moving on to scanning the next study area. The minimum information needed for each marine mammal sighting is provided in Table 2.

General rules to consider during the visual observations of marine mammals are:

- If majority of narwhal are travelling in one direction (i.e., north → south), begin scanning the survey area from the opposite direction (i.e., south → north) in order to avoid / minimize double-counting.
- During incoming vessels, begin counts in the study area closest to the incoming vessel.
- The observer is to spend a minimum of 7.5 minutes scanning each study area (A, B, C, D), but may take additional time if there are many sightings to be made.
- Record all whale sightings as you would a narwhal sighting.
- Seals and walrus observed are to be documented in the comments section of the database. Include a descriptive comment in the data sheet including information on species, group size, and behavior (as possible). Always prioritize whale sightings.
- Data will not be collected for the study areas that cannot be observed in its entirety due to weather. When the study areas is omitted due to weather, glare and sightability must still be documented at each watch period. Communicate any reduction in sightability and your ability to detect marine mammal sightings to the Data Recorder.
- During narwhal herding events, record the start and end time of a herding event into the survey area and the animals primary travel direction. Record any changes to travel direction.

¹ To be confirmed and must match the recorders that JASCO has in the field

³ Mann, J. 1999. Behavioral sampling methods for cetaceans: a review and critique. *Marine Mammal Science* 15(1): 102-122.

MMOs will also characterize vessels passing through the survey area, and any other anthropogenic activities such as narwhal or seal hunting events which may affect the distribution and behavior of marine mammals. The minimum information needed for each vessel sighting is provided Table 7.

General rules to consider during the visual observations of marine mammals are:

- For all vessel traffic, vessel class⁵ is to be determined and documented.
- General description of travel direction within the survey area.
- Multiple sightings are to be taken to the vessel, as possible, dependent on the speed of travel through the survey area. A sighting is taken by providing a pelorus (radial angle) and a clinometer (slope) reading.
- When possible ask the captain for a description of the vessel from the shipboard AIS.
- Fixed-wing aircraft and helicopters are to be noted in the 'comments' section of the data sheet if present, including aircraft travel direction.
- Any hunting/shooting events, the associated time, general location of hunting/shooting events, and target species whenever possible.
- Environmental conditions will also be observed and document by MMOs, upon arrival to the monkey bridge each day, at the start of every visual survey on the hour, and whenever conditions change. Specific environmental conditions for each study area (A, B, C and D) described in Section 5.11. The data recorder can assist in collecting this information each day.

Table 3: Minimum data recorded for each marine mammal sighting

Data to be recorded	Description
Start / End time	Start and end time of each study area scan. A Garmin GPS way point will also be taken and recorded in the database.
Time of sighting	Time of sighting (automatic in the database)
Sighting #	For each group of animals observed in the survey area, a sighting number is to be used as a unique identifier. If a group of animals remains in the survey area for a period exceeding 10 minutes, that group is to be 're-sighted' every 10 minutes until the group leaves the survey area. In this scenario, the initial sighting number is to be repeated as a new line item in the datasheet, along with the associated time of the new sighting data collected.
Distance to marine mammal	Estimate the distance from the FRV <i>Nuliajuk</i> to the narwhal.
Clinometer reading	Use the clinometer and provide a slope to the data recorder.

⁵ Vessel class: Small = 0-50m; medium = 50m-100m; large = \geq 100m

Data to be recorded	Description
Radial Angle to marine mammal	Use pelorus to determine the radial angle to the marine mammal.
Whale species	Although narwhal are the focal species of this program, all other whale species observed are to be recorded as a separate sighting (with the same level of detail as would be provided for narwhal). Seals and walrus are to be noted in the comments section only.
Group size	Number of narwhal within 1 body length of one another. Includes group size of 1.
Direction of Travel	N, S, E, W, or N/A if group travel is multi-directional such as milling.
Study Area Glare	None, Light, Moderate, or Severe glare assessment
Study Area Sightability	Subjective assessment of sightability (see Section 5.11)

Group Composition and Behaviour Data (Additional Data)

Additional group composition and behavioral data are to be recorded for each marine mammal sighting as possible. This may become very challenging at distances greater than 1 km, or when many narwhals are herding through the survey area, in which case the minimum data listed in Table 3 is sufficient.

General rules to consider during the collection of group composition and behavior data are:

- Primary⁶ (1) and secondary⁷ (2) behavioral data are to be recorded for every sighting whenever possible, based on seven behavioral categories⁸ (Table 7).
- Unique behaviors⁹ are also to be recorded in the datasheet whenever observed.
- If a group of animals remains in the survey area for a period exceeding 10 minutes, that group is to be 're-sighted' every 10 minutes until the group leaves the survey area. In this scenario, the initial sighting number is to be repeated as a new line item in the datasheet, along with the associated time.
- If multiple groups pass through the survey area too quickly such that group composition and behavior cannot be recorded, focus on obtaining the minimum information needed, as provided in Table 2.

The following tables outline the group composition data (Table 4, Table 5, and Table 6) and the behavioral data (Table 7) that is to be recorded for each sighting within each survey.

⁶ Primary behavior = the behavior displayed by the majority of animals; the predominant behavior.

⁷ Secondary behavior = the second most commonly observed behavior of a group of animals.

⁸ Behavioral categories (see Table 6) = travelling, resting, milling, foraging, socializing, reproductive, other.

⁹ Unique behaviors (see Table 6) = logging (LO), chase prey (CH), catch prey (CA), rubbing/petting (RU), rolling (RO), tusk (TU), tail slap (TS), nursing (NU), mounting (MO), sexual display (SX), bubble rings (BU), spyhopping (SP), breaching (BR), diving (DY).

Table 4: Group Composition and Behavior Data

Speed of travel	<ul style="list-style-type: none"> ■ Slow ■ Medium ■ Fast / Porpoising ■ Not travelling / Milling
Spread	<ul style="list-style-type: none"> ■ Tight: narwhals \leq body width apart ■ Loose: narwhals >1 body width apart
Group Formation	See Table 6 (Formation).
Number of narwhals with tusks	<ul style="list-style-type: none"> ■ Present ■ Absent ■ Unknown (i.e., head not visible).
Number of narwhals in age categories adult, juvenile, yearling, and calf.	See Table 5 (Life stages).
Primary & Secondary Behaviour	<ul style="list-style-type: none"> ■ See Table 7 (Behavioural Data).
Associated photo range	<ul style="list-style-type: none"> ■ For each sighting where photos are taken, the numeric photo range should be recorded and linked to the sighting.

Table 5: Life Stages of Narwhal

	Adult	Juvenile	Yearling	Calf
Length	4.2 – 4.7 m	80-85% length of adult	2/3 of accompanying female	½ length of accompanying female, usually in “baby” or “echelon” position close to mother. Newborn calves are -1.6 m in length.
Colouration	Black and white spotting on their back, or mostly white (generally old whales)	Dark grey; no or only light spotting on their back	Light to uniformly dark grey	White or uniformly light (slate) grey, or brownish-grey

Table 6: Group Formation Categories





Linear	Parallel	Cluster / circular	Non-directional line	No formation
Directional line	Directional line	Directional line	Non-directional line	Non-directional line
Stretched longitudinal	Stretched laterally	Stretched longitudinal + lateral	Linear formation	Non-linear
One animal after another in a straight line	Animals swimming next to each other in a line formation	Animals swimming in cross formation (equally long as wide lines)	Animals in a linear line but facing different directions	Equal spread with no clear pattern
				

Table 7: Behavioral data (primary and secondary) to be recorded

Behavior	Description of behavior	Unique behavior examples	
Travelling	Animal(s) exhibiting directed movement; moving steadily in a constant direction	-	
Resting	Animal(s) not moving	Logging (LO)	
Milling	Animal(s) exhibiting non-directional movement; moving about haphazardly and slowly within a limited area	-	
Foraging	Animal(s) chasing or catching prey species. Prey could be seen.	Chase prey (CH) Catch prey (CA)	
Socializing	Animal(s) in physical contact with one another; includes tail slaps	Rubbing or petting (RU) Rolling (RO) Tusk displays or tusk contact (TU) Tail slap (TS)	

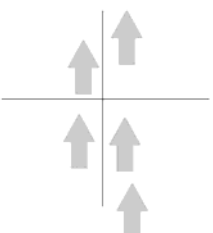
Behavior	Description of behavior	Unique behavior examples	
Reproductive	Animal(s) exhibiting behavior known to be related to reproductive function	Nursing (NU) Mounting (MO) Sexual display (SX)	
Other	Animal(s) exhibiting behavior not known to be context-related. A description of behavior is to be included in comments.	Bubble rings (BU) Spyhopping (SP) Breaching (BR) Diving (DY)	

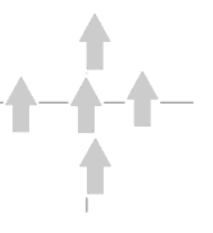
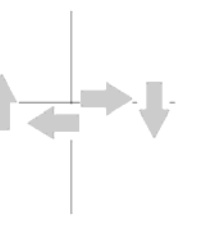
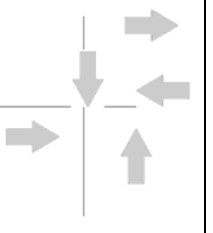
Table 8: Vessel and anthropogenic data to be recorded

Data to be recorded	Description
Start / End time	Start and end time of each vessel transit or hunting/shooting event. A shot fired can be classified as a single event if additional shots are not fired within a few minutes. Gamin GPS waypoint should be taken and recorder in the database.
Vessel Sighting ID	Sequential numbering of each vessel transit (automatic in the database)
Distance to Vessel	Estimate the distance from the FRV <i>Nuliajuk</i> to the vessel.
Clinometer reading	Use the clinometer and provide a slope to the data recorder.
Radial Angle to Vessel sighting	Use pelorus to determine the radial angle to the vessel.
Vessel direction of travel	N, S, E, W
Vessel class	<ul style="list-style-type: none"> ■ Large: ≥ 100 m ■ Medium: 50-100 m ■ Small: Hunting and pleasure crafts; < 50 m
Hunting Activity location	General description of the location of the hunting/shooting event.
Description of Hunting Activity	Describe target species, number of shots fired, time of shots, and any other relevant information.
Associated photo range	For each sighting photographed, the numeric photo range is to be recorded and linked to the sighting.

5.7 UAV

A team of two individuals (the UAV pilot and a UAV observer) will collect information on group composition and behavioral data on all sightings made by the MMOs within 1 km of the vessel (extent of the UAV abilities). The UAV team will communicate their observations to the Data Recorder.

Behaviours will be collected as per Mann (1999); data to be collected is as follows:

- Narwhal group composition.
- Narwhal group primary and secondary behavior.

5.7.1 Roles and Responsibilities

Table 9 outlines the roles and responsibilities as well as what equipment each role will need during the survey.

Table 9: Roles and Responsibilities

Role	Responsibility	Equipment
UAV Pilot	<ul style="list-style-type: none"> ■ Operates the UAV 	UAV
UAV Observer	<ul style="list-style-type: none"> ■ Document group composition as well as primary and secondary behavior of all narwhals within 1 km of the vessel. Specific behavior (e.g. tusking) within each of the five behavioral categories should be documented whenever possible. ■ Communicate all observations to the Data Recorder. ■ Complement the data collected by taking photographs of narwhal and vessels whenever time permits. ■ Assist UAV Observer or MMOs with documenting sightings, as necessary. 	UAV video screen
Data Recorder 1 and 2	<ul style="list-style-type: none"> ■ Record all information received from the UAV Observer. ■ Record environmental conditions every hour and ■ All times should be recorded using UTC 	HD camera, 7 x 50 binoculars, Database or Datasheets ¹⁰

¹⁰ Datasheets: Group Composition and Behavior, Environmental Conditions

5.7.2 Protocol

The UAV survey protocols to be used will also follow Mann (1999¹¹). Each flight will last approximately 20 minutes depending upon weather conditions and will attempt to identify all marine mammal groups¹² (including a solitary narwhal which would be considered a group of 1) within the study area before moving on to the next sighting (identified by the MMOs). The minimum information needed for each marine mammal sighting is provided in Table 3.

General rules to consider during the visual observations of marine mammals are:

- Each flight will last approximately 20 minutes depending upon weather conditions.
- If majority of narwhal are travelling in one direction (i.e., north → south), begin scanning the survey area from the opposite direction (i.e., south → north) in order to avoid / minimize double-counting.
- During incoming vessels, begin counts in the study area closest to the incoming vessel.
- Data will not be collected for the study areas that cannot be observed in its entirety due to weather. When the study areas is omitted due to weather, glare and sightability must still be documented at each watch period. Communicate any reduction in sightability and your ability to detect marine mammal sightings to the Data Recorder.
- During narwhal herding events, record the start and end time of a herding event into the survey area and the animals primary travel direction. Record any changes to travel direction
- As stated earlier information regarding number of individuals, group composition and behaviour should not be shared between the MMO and UAV teams.
- Specific protocols for the UAV team will follow Golder's Directive for using the UAV is provided in APPENDIX C for reference.

5.8 Observing Techniques

To ease the strain on the observers' eyes, two types of scanning techniques are used to detect marine mammals: U and S scans (Figure 3). S scan method consist of scanning the water parallel to the horizon (in an s-shaped pattern) and U scans consist of scanning the water perpendicular to the horizon (shaped like the letter u). These scanning techniques should be used every 20 seconds to avoid observer fatigue. These are some helpful hints to implement in your active scanning routine:



- Continuously scan the water with the naked eye using the S and U techniques.
- Use binoculars only to focus in on possible sightings. Binoculars decrease your observing area by focusing your view on a small area so it is best not to use them to scan.

¹¹ Mann, J. 1999. Behavioral sampling methods for cetaceans: a review and critique. *Marine Mammal Science* 15(1): 102-122.

- Be ready to observe the next sighting, so keep your eyes moving and scanning the field of view as soon as possible after gathering all information about a sighting.
- Regularly change the distance of your view, do not just look at the horizon or just at the water close to the vessel.
- Watch for sighting cues (discussed in more detail below).

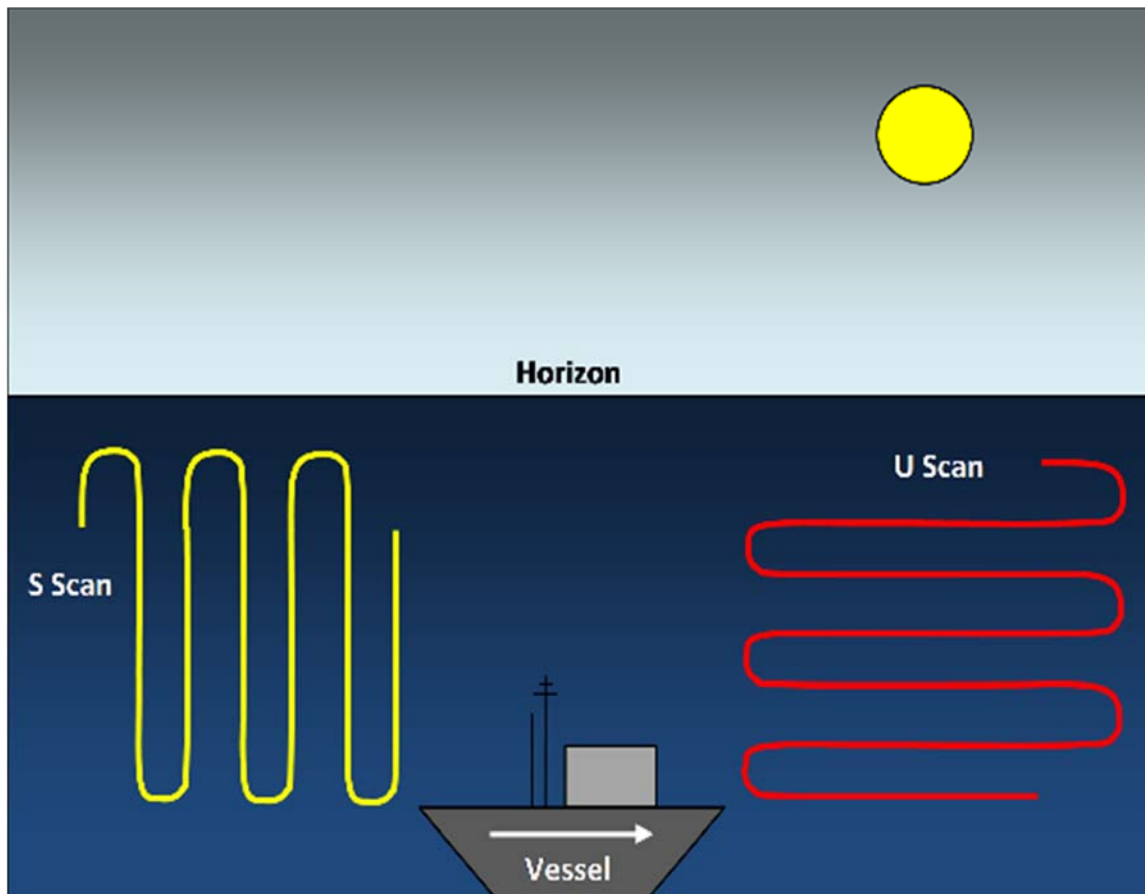

Figure 3: S and U Scanning Techniques to be used during Marine Mammal Observing

5.9 Estimating Distances

Accurately estimating distances is the most important MMO skill and is learned with regular practice. Some helpful resources when trying to estimate the distance to a sighting is:

- use the known distance to shore (from nautical maps, ship vessel radar, GPS plotters) as a reference;
- ask others on the bridge – the crew is a great resource;
- if available use the reticle binoculars; and
- take clinometer readings.

Calculating distance using reticule binoculars

Reticular binoculars can be used to estimate the distance to a sighting if the following information is present/known:

- a horizon is present and is not obscured (by fog or land)
- the height above sea-level to the eye of the person sighting the marine mammal is known

It is useful to generate a distance table (see Table 10) prior to the start of a field program once the MMO have been identified (eye height is known) and the vessel platform has been decided (platform high above sea level).

Making a Distance Table

Estimating distances based on reticle readings depends on the distance to the horizon which is dependent on

- the height of the observer eye above sea level in meters
- radians per reticle mark for the type of binoculars you are using

The milliradians (mils) per reticle mark for Fujinon 7 X 50 reticle binoculars is 5 (Fujinon 2006). We use this number to produce a distance table for each project and each person (if the height of individuals differs significantly) using the following equation:

$$\text{Distance} = (\text{eye height} + \text{height above sea level in meters}) \times 1000 / \# \text{ of mils or milliradians}$$

For the purposes of this manual we have assume that everyone is 1.8 m to eye level. We know that the height of the bridge is 20 m above sea level = total 21.8 m. With these assumptions we can generate the following table.

Table 10: Distance Table Example

Number of Reticles	# milliradians (mils)	Eye Height* + Height Above Sea Level	Distance in Meters to Sighting
1	5	21.8	4360
2	10	21.8	2180
3	15	21.8	1453
4	20	21.8	1090
5	25	21.8	872
6	30	21.8	727
7	35	21.8	623
8	40	21.8	545
9	45	21.8	484

Number of Reticles	# milliradians (mils)	Eye Height* + Height Above Sea Level	Distance in Meters to Sighting
10	50	21.8	436
11	55	21.8	396
12	60	21.8	363
13	65	21.8	335
14	70	21.8	311

Notes:

Distance = (eye height + height above sea level in metres) x 1000 / # of mils (Fujinon 2006).

Assumptions: eye height = 1.8 m, height above sea level = 20 m (for MSV *Botnica*)

* Eye height will change with each individual

Each Reticle = 5 milliradians also called mils

How to use the Fujinon reticle binoculars:

1. make sure your binoculars are in focus
2. line up the top reticle line with the horizon
3. count from the horizon (top reticle) down, how many lines there are to the marine mammal. Measure the point where the animal breaks the water surface, and not the height of the blow.
4. use the number of lines counted and the distance calculation table to find out the distance to the marine mammal

Example: Look at Figure 4 and estimate the distance to the marine mammal using Table 10 above.

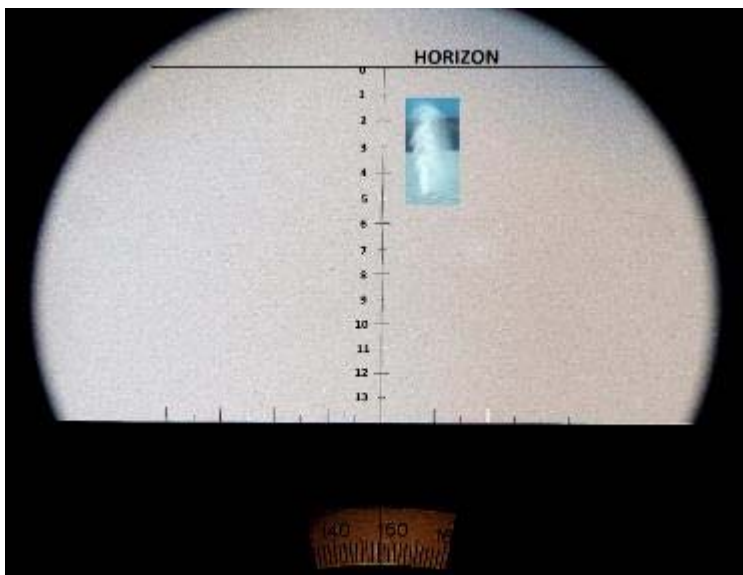

Figure 4: Calculate the Distance to the Marine Mammal

Using a clinometers

A clinometer is used alongside distance estimation to get a more accurate reading of the distance to a marine mammal or vessel sighting. Hold the clinometer to your eye and with both eyes open, look simultaneously through the lens and alongside the housing. A horizontal sighting line will appear. Raise or lower the clinometer (by tilting your head) to place the sighting line on your target. Read the number closest to the sighting line which will be recorded in the database.

5.10 Detection Cues

Marine mammals spend most of their time underwater, therefore, MMOs only have the ability to spot them when they are at the surface which in most instances is for a very short period of time. Detection cues are useful to know as they can mark the presence of marine mammals even when they have not fully surfaced. Below is a list of detection cues that will be useful to know when performing MMO duties.

Splashes in the water

Splashes may be a sign that a marine mammal is present (Figure 5).



Figure 5: Splash

Footprints

Footprints are when the surface of the water looks disturbed and are made when a marine mammal has just been on or near the surface of the water (see Figure 6).



Figure 6: Footprint from Marine Mammal

Birds

Birds may be attracted to marine mammal when they are feeding. Keep an eye out for bird aggregations near the surface of the water and diving into the water (Figure 7).



Figure 7: Birds on the Water with Whale

Blows

Marine mammals breathe air and are forced to surface even if only for a short time. When whales surface, they often expel a watery mist from their blow holes. Blows vary in size and can be seen from very far distances. This is the one of the most common detection cues. During calm conditions, blows may also be heard.

Baleen whales (bowhead whales) and toothed whales (narwhals, belugas and killer whales) have different blows.

Toothed whale blow (Narwhals, Belugas and Killer Whales)

Because toothed whales have a single blow hole and because they are smaller animals than the baleen whales we might observe (bowhead whales), their blows are shorter and wider than baleen whale blows (Figure 8). Blows of toothed whales are not often seen from far distances, and at times, not seen at all.

Baleen whale blow (Bowheads)

Because baleen whales have two blowholes, their blows are wider apart and sometimes make a V-shaped or heart-shape (Figure 8). Baleen whale blows are also much higher than toothed whale blows at times, can be observed from greater than one kilometer away.



Figure 8: Toothed whale blow (left) versus baleen whale blow (right)

5.11 Environmental Variables

Environmental variables that are important to record during the surveys are:

- ice cover
- precipitation type
- cloud cover
- beaufort wind force
- sea state
- sightability
- sun glare

Environmental variables are important to record because they can alter the ability to spot and identify marine mammals as well as influence the distribution of marine mammals. This information is used during reporting to analyze the MMO effort and marine mammal distribution.

Ice Cover

There will likely be ice present during the program. As the presence of ice can affect the distribution of marine mammals it is an important condition to record. Ice cover will be recorded in a percentage cover of your field of view. Please not any additional comments you may have about the ice in the notes of the database.

Precipitation type

Precipitation in the form of snow, fog, and rain reduces the area visible to the observer and can affect the ability to spot and identify marine mammals.

Beaufort Wind Force

Wind is the major environmental condition affecting wave height and shape. In general, stronger winds produce larger and rougher waves. High winds causing rough sea conditions can make it very difficult to spot and identify marine mammals. The Beaufort wind force scale is an international scale that ranks wind speeds into 12 categories (0 to 11). Wind speed is recorded in knots and is usually monitored by a dedicated instrument on the vessel called an anemometer. When you get on board, ask a crew member where to obtain readings on wind speed and direction. Table 11 describes the main Beaufort wind force categories.

Table 11: Beaufort Scale for Wind Force

Wind Speed (knots)	Beaufort Wind Force	Description
<1	0	Calm
1–3	1	Light air
4–6	2	Light breeze
7-10	3	Gentle breeze
11-16	4	Moderate breeze
17-21	5	Fresh breeze
22-27	6	Strong Breeze
28- >64	7-12	Near gale to hurricane

You can also estimate wind speed based on the sea state observed. Table 12 describes the type of sea conditions that correspond to the Beaufort wind force categories.

Sea State

Sea state greatly affects MMOs abilities to spot and identify marine mammals. Sea state is measured in wave height in metres. Wave height is measured from the bottom of a wave (trough) to the top (crest) of the adjacent wave (Figure 9).

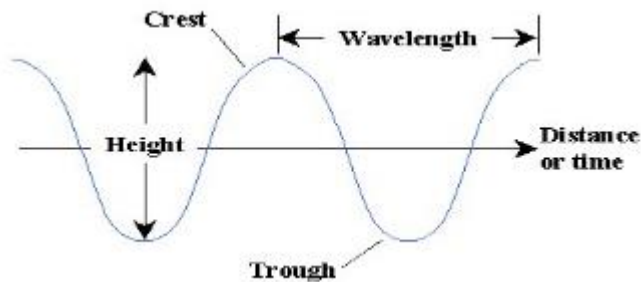









Figure 9: Wave Characteristics

Sea state is also measured in categories. It is broken into 11 categories, numbered 0 to 9 (Table 12). It is a good idea to carry a copy of the sea state table with you when you go on an MMO program and have it visible in an area where you are performing your duties. It is important to note that the sea state scale **does not** quite match the Beaufort wind force scale.

Table 12: Sea States Categories and Corresponding Descriptions in relation to Beaufort Wind Force

Wave Height (m)	Sea State	Description	Beaufort Wind Force	Picture of Sea Condition
0	0	Glassy	0	

Wave Height (m)	Sea State	Description	Beaufort Wind Force	Picture of Sea Condition
<0.1	0.5	Ripples	1	 A photograph showing the sea surface with small, gentle ripples. The water is a dark blue-grey color. In the foreground, the red deck and white railings of a ship are visible.
0-0.1	1	Small wavelets	2	 A photograph showing the sea surface with small, distinct wavelets. The water is a deep blue color. In the foreground, the white railings of a ship are visible.
0.1-0.5	2	Smooth wavelets	3	 A photograph showing the sea surface with smooth, slightly larger wavelets. The water is a dark blue color. In the foreground, the white railings of a ship are visible.
0.5-1.2	3	Slight; small white caps	4	 A photograph showing the sea surface with slight, small white caps. The water is a dark greenish-blue color. In the foreground, the white railings of a ship are visible.

Wave Height (m)	Sea State	Description	Beaufort Wind Force	Picture of Sea Condition
1.2 - 2.4	4	Moderate waves, some spray	5	
2.4 - 4	5	Rough, larger waves	6	
4 - 14 plus	6 - 9	Very rough to extremely high	7 - 12	

Notes: Photos retrieved from <http://thegiddyupplan.blogspot.ca/2011/03/noaa-beaufort-sea-state-images.html>

Sightability

Sightability is based on a number of environmental variables (weather, glare, sea state etc.). This factor plays a major role in your ability to spot and accurately identify marine mammals, particularly at a distance. Sightability will be recorded as:



- Excellent (E): conditions such that 100% certain that marine mammals at surface would be detected.
- Good (G): conditions such that marine mammals at surface would *very likely* be detected.
- Moderate (M): conditions such that marine mammals at surface may be detected.
- Poor (P): water is mostly obscured by fog, ice, or high sea state; detections severely impaired and unlikely.
- Impossible (I): water is completely obscured by fog, ice, or high sea state.

Sun glare

Sun glare can also greatly affect a MMO’s ability to spot and identify marine mammals. Sun glare is recorded in the environmental observation form. Table 13 outlines what each sun glare description represents. The percent the sun glare is taking up in your field of view (FOV) is also recorded, as well as the where the sun glare starts and ends in the FOV (the relative position of the glare is recorded either in degrees or in clock position).

Table 13: Sun Glare

Sun Glare Description	Picture of Description
None (N)	

Sun Glare Description	Picture of Description
Light (L)	
Moderate (M)	
Severe (S)	

5.12 Recording Data

One of the most important parts of your work will be to carefully enter information on all sightings/observations during your watch. This information is critical to the success of the Bruce Head Program. A lot of time and mentorship will be spent on training to properly, efficiently and consistently record information.

The Golder Field Lead/Data Recorder will be recording all the information provided by the MMOs and UAV observers. The Bruce Head Program will use either specially designed electronic database on a laptop or hard copy datasheets (provided in APPENDIX D).

o:\final2016\3 proj\1663724 baff_marinemammalsurvey_ont\1663724-077-r-rev0\1663724-077-r-rev0-brucehead2018 training manual 31jul_18.docx

APPENDIX A

Vessel Safety Orientation

TECHNICAL MEMORANDUM

DATE 31 July 2018

Project No. 1663724/11000

TO Jared Gardner
Baffinland

CC

FROM Golder Associates

EMAIL

BRUCE HEAD MONITORING TRAINING MANUAL – VESSEL SAFETY

1.0 INTRODUCTION

This document has been prepared specifically for vessel related monitoring programs related to 2018 field activities in conjunction with Baffinland Iron Mine Corporation (Baffinland), Baffin Island. This portion of training manual has been prepared to provide personnel with information relating to personal safety and potential conditions at sea. The safety orientation has been designed to give employees:

- A basic understanding of hazards associated with vessels operating in marine environments
- An overview of how to react to and potentially deal with on-board emergencies and
- The important steps in survival and rescue

This manual does not qualify as Transport Canada certified training but contains practical information for mariners and takes into consideration information available within the *Canada Shipping Act (2001)* and associated *Safe Work Practices Regulations* (available at: http://laws-lois.justice.gc.ca/eng/regulations/C.R.C.,_c._1467/page-1.html#h-3). The Regulation applies to the employment of persons in any working area associated with any ship in Canada or on any Canadian ship outside Canada. Section 3.0 includes a partial overview of Transport Canada's Marine Publication "*Personal Safety on Ships*" (Document TP5021E; available at: <https://www.tc.gc.ca/media/documents/marinesafety/tp5021e.pdf>).

2.0 GENERAL SAFETY FOR ALL SHIP MEMBERS

Working in remote locations on vessels where field staff and passengers have limited experience can be potentially hazardous. To minimize risks on-board every employee of the vessel shall:

- Work in a manner that does not endanger the safety or health of other persons on the ship or related work. This includes using procedures and techniques that are intended to prevent/reduce risks.
- Maintain equipment in safe working condition and not use machinery or equipment for any purpose other than the purpose for which it is intended to be used.

- Take all reasonable and necessary precautions to ensure their own safety and the safety of their fellow employees including using devices and wearing articles of clothing or equipment that are intended for their protection and provided to them by their employer.
- Not obstruct emergency exits and lifesaving equipment.
- Observes work areas and immediately report potentially unsafe conditions or situations to a qualified person in charge of the working area.
- Report accidents or an injury to personnel immediately to the person in charge of the working area.
- Not be permitted in any working area where their ability to work is, in the opinion of the person in charge of the area, impaired by alcohol or a drug (Refer to Golder's *Fit for Duty Policy*).
- Not be assigned to any work of any kind when, an impairment, injury, or disability is likely to endanger that person or any other person.
- Be limited to the operation of equipment they are qualified and intended to use.

3.0 PERSONAL SAFETY, HEALTH, AND ON-BOARD CONSIDERATIONS

Every year more than 1000 marine incidents are reported to the Canadian Marine Administration of Transport Canada. Although work on board ships can be dangerous, many incidents could be avoided if proper safety procedures, as laid down in Canada's "*Safe Working Practices Regulations*", were followed.

Health

Keeping fit and staying healthy are as important on a ship as elsewhere. Illness may reduce your ability to concentrate on a job and increase on-board risks and the potential for accident. Good health depends on a balance of work, rest and recreation, regular hydration, nutritious meals, and adequate sleep. Personal cleanliness and hygiene are paramount to maintaining good health and the health of others.

It is the responsibility of every employee to ensure inoculations and vaccinations are kept up to date.

Inform the captain, first-aid attendant or program lead of any potential medical issues which may affect your health while at sea.

Clothing

Sufficient clothing for protection from the cold is the first and most important requirement for survival in cold climates. It not only improves working conditions but is most important in combating hypothermia in a survival situation. *Cotton is not recommended*. Considerations for clothing in cold environments include wearing multiple layers. It is easier to regulate body temperature in changing conditions with layers. Layers include:

- First layer – long underwear; snug fitting and non-absorbent - synthetic (polypropylene) or natural fibers (wool or silk).
- Mid-layer – shirts, sweaters, pants; wear something that fits and traps air preventing cooling circulating air that removes body heat - synthetic (polypropylene) or natural fibers (wool or silk) work best.

- Insulation layer – thickness is warmth (e.g. down jacket); down loses loft when wet, synthetics work well in wet environments.
- Outer layer/shell – windproof but not necessarily wet-proof. In dry environments, breathable windshells allow moisture from the body to escape.
- Pants – dependent upon moisture level thick pants may be enough; rain pants work well to keep water out.
- Headwear – protecting your head and face is important. Toques and baseball hats are useful but if windy consider using a balaclava. Fur is the warmest.
- Gloves – liners help increase the warmth of any glove; mitts are generally warmer than gloves.
- Footwear – comfortable supportive footwear that meets the requirements for moisture and insulation is recommended.

Personal Protective Equipment (PPE)

Personal protective equipment (PPE) is a worker's last defence against injury and death, when eliminating workplace hazards is not possible. Depending upon the nature of work PPE could include footwear, gloves, eye protection, immersion suits, life jackets, hi-vis clothing. A complete list of required PPE is provided in the project-specific Health, Safety, and Emergency Plan. When working on deck a PFD is required at all times.

4.0 HAZARDS & EMERGENCIES

Emergencies can be caused by a many number of factors including weather, medical issues, lack of training, carelessness, and equipment malfunction. Emergencies at sea are potentially life threatening. Common emergencies include: capsizing, collisions (ground or any other vessel), man overboard, equipment failure, fire, and injuries or medical problems requiring a higher level of care.

In an emergency any person may take whatever measures are necessary to prevent loss of human life or injury to persons.

4.1 General Mitigation and Preparedness

Maintaining a general state of safety on a vessel is important in minimizing the risk of crew and passengers. Having the mindset of being prepared and thinking ahead help in being organized and ready for many situations. Valuable preparation and organization points include:

- Visiting all areas of the vessel where you will be working and becoming familiar with safety equipment at those locations -
 - Location of pfd's, life jackets, immersion suits and how to use them
 - Location of ship-board firefighting equipment (extinguishers, axes, hoses, blankets, etc.)
 - Location of EPIRBs (Emergency Position Indicating Radiobeacon) and VHF radios
 - Location of first aid kits, emergency blankets, and first aid supplies

- Location of life rafts, platforms, lifeboats, and other means of abandonment
- Location and use of re-boarding devices
- Location of muster points
- Understand safety labels, symbols, signs, and posted safety directives
- Location of weather and water-tight doors
- Housekeeping and overall tidiness (e.g. remove trip hazards, and tie down projectiles)
- Clean up spills and use signage as necessary
- Keep passageways clear, do not store gear in them
- Proper storage and maintenance of tools and equipment

4.2 Equipment Failure

Failures can occur at any time. Equipment failures can include steering, engine, pumps, or other vital systems. An anchor should be deployed to control ship movement and stabilize the vessel location. Leave problem solving and troubleshooting to trained on-board crew members. Notify crew members if subsequent failures or related issues arise.

4.3 Fire and Explosion

Fires and explosions are commonly found in engine rooms, galley (cooking areas), flammable storage areas, crew quarters, and electrical panels.

Depending on the type of fire the best method for suppression will vary. Fire requires heat, fuel, and oxygen. Remove any one of these elements and the fire will go out.

There are five different classes of fire. Refer to Table 1 for fire classes and the best method and apparatus to aid in extinguishing them. All crew member should be familiar with the different class of fire extinguishers onboard their vessel and their proper use.

Table 1: Classes of Fire and Associated Extinguisher type

Fire Class	Type of Material	Method / Extinguisher Type
A	Ordinary combustibles such as wood, paper, trash or anything else that leaves an ash.	Water works best to extinguish a Class A fire but foam and dry chemical extinguishers also work well.
B	Flammable or combustible liquids. Include oil, gasoline, butane and other similar materials	Smothering which depletes the available oxygen supply works best to extinguish Class B fires. Foam and carbon dioxide extinguishers work well.

Fire Class	Type of Material	Method / Extinguisher Type
C	Energized electrical fires	De-energize the circuit then use a non-conductive extinguishing agent (e.g. carbon dioxide).
D	Combustible metal fires	Do not use water to extinguish it. Dry powder extinguishers work best by smothering and absorbing heat.
K	Kitchen fires involving cooking oils, grease and animal fat	Turn off the heat source. Do not use water. Remove the oxygen (e.g. cover) and if required use a smothering agent (fire blanket, dry chemical extinguisher, salt or baking soda)

4.4 Collision / Grounding

Collision can include the seafloor (grounding) or another vessel. Collision is potentially caused by many factors including navigation error, poor weather, equipment failure, and also human factors such as crew fatigue, lack of knowledge of the area, unsafe speed, or no look out posted. In the event of a collision, the captain and crew will inform passengers of appropriate actions. If a collision is damaging enough personnel should be prepared to abandon ship. First aid may be required to members of either ship. Collision or grounding can lead to many other emergencies such as fire, flooding, and medical emergencies.

4.5 Flooding

Flooding can occur from overloading, failed pumps or bilges, broken through-hull valves, leaky hull, and many other potential reasons. The vessel’s crew will check below deck areas and the bilge on a frequent schedule. In large seas assist where possible and help to ensure the vessel is watertight.

4.6 Capsizing

Capsizing can occur as a result of poor seamanship, bad weather, incorrect loading (including ice-buildup, called icing). Capsizing usually leads to an “Abandon Ship” emergency response. In the arctic, capsizing is a serious emergency due to the risk of exposure. Important things to remember:

- Locate all personnel who were aboard
- Stay with smaller boats but get away from larger vessels (>12 m) they can create suction when sinking
- Get as much of yourself out of the water. Your body loses heat 25x faster in water.
- Locate the life raft and any floating emergency equipment
- Deploy the EPIRB and radio a distress signal

4.7 Man Overboard

"Man overboard!" is a term given aboard a vessel to indicate that someone has fallen off the ship into the water and is in need of immediate rescue. It can happen quickly; a slip on a slick deck, leaning too far without a handhold, or a momentary loss of balance.

Whoever sees the person first yells "Man Overboard!" and watches the person the entire time. The initial spotter should not take their eyes off the victim and throw a floating object into the water to a) assist the victim and b) assist the spotter. Spotting a person even at a short distance away in anything but calm seas can be extremely difficult. Observers are required to wear PFDs while on-deck at all times.

The captain of the vessel must ensure there are procedures in place for recovering a man overboard. A rigged ladder is the easiest way to re-board a vessel but ropes and other improvisations may be required.

4.8 Medical Emergencies

Medical situations can happen at any time. Some medical conditions are preventable with proper proactive care, such as medication or safe working environments, however, some are not. Vessel crew should be certified in first aid, and some larger vessels will have a medic onboard.

4.9 Icing

Icing over of parts of the vessel can occur quickly in cold water environments. Ice-build up is the accumulation of ice on a vessel, and may lead to serious stability problems as well as slippery decks for crew to walk around on. The danger increases with colder temperatures and stronger winds. Ice on the surface of calm waters can sometimes be thick and invisible, commonly known as black ice, and can compromise the water tightness of the vessel hull if approached at great speeds.

4.10 Weather

Weather can create many problems for vessels and their crews. Potential issues include decreased/poor visibility, high winds, large waves, and icing. Continuous monitoring of the radio for updates and forecasts is necessary. Expect poor weather if dark clouds or puffy tall clouds (*cumulus nimbus*) are present.

Be prepared for sudden unexpected vessel movements and use three points of contact while moving around the vessel. Wear appropriate outdoor clothing (layers and PPE) while on deck and be prepared. Secure loose objects on deck and within the vessel. Rough seas can occur for several hours after wind events.

5.0 EMERGENCY RESPONSE

All vessel crew will be trained in emergency response and know what to do and be familiar with onboard equipment in case of an emergency. As a passenger, you should become familiar with exits and equipment prior to emergency and always try to remain calm and follow direction from the crew. Awareness of what is going on

and how to respond is a useful tool in understanding the emergency and act accordingly. You may also be the first person to identify a hazard onboard that could quickly become an emergency if undealt with. It is your duty to communicate all hazards or potential risks to a crew member.

Familiarize yourself with the location of all emergency equipment, muster stations, and exits. Familiarize yourself with the proper use of emergency equipment. A vessel orientation will be provided by a qualified crew member.

5.1 Muster Station

A muster station is used for crew and passengers to gather in the event of an emergency and is situated in an area where people can quickly leave the vessel, if required. This is usually outside on deck near emergency safety devices such as life rafts, emergency boats, life rings, and safety equipment.

5.2 Signals and alarms

If you are the first person to identify an emergency onboard, it is your duty to notify the crew of the emergency. There are ways to “raise the alarm” of an emergency by using specific alarm signals that are broadcasted across the vessel so that all crew and passengers are notified. If you hear an alarm, go directly to the Muster station. Most vessels will have common emergency alarm signals, which are:

- General Emergency Alarm signal: 7 short blasts followed by 1 prolonged blast.
- Fire Alarm signal: 1 continuous blast.
- Man Overboard signal: 3 prolonged blasts.
- Abandon ship signal: This is a verbal order from the vessel’s Captain

5.3 Muster list

Emergency response management is a critical component of bringing an emergency under control. All vessel crew are assigned designated roles during each type of emergency and the roles are identified in a Muster List. The List is generally posted at multiple conspicuous locations throughout the vessel (e.g., galley, bridge, and crew accommodations) and describes emergency response duties to be carried out by specific crew members and helps account for all crew and passengers onboard.

Muster lists specify the following:

- Signals identifying various emergencies
- Assigned muster stations for each crew member and passenger
- Assigned duties for each crew member, including duties assigned to protect passengers
- Substitute assigned duties for each member, in case persons become disabled to respond to the emergency.

The vessel orientation will indicate whether you have an active role in emergency response onboard the vessel.

5.4 Drills and Training

It is the Captain's responsibility to ensure that all crew are trained on emergency response and proper use of safety equipment. Crew undergo frequent emergency response drills to practice their muster list roles. Practice also assists in reducing panic and stress and assist in keeping a calm demeanour. The vessel Captain may also choose to practice drills while passengers are onboard, as a real-life simulation for an emergency that can happen at any time. All equipment used during training must immediately be returned to operational condition and readied for emergency use.

6.0 MARINE FIREFIGHTING

Most fires are caused by humans. They never just happen. In many cases fires are preventable. Many vessels are beginning to use fire retardant paints on wood and other flammable structures to slow fire spread. Important things to remember when fighting a fire at sea:

- Raise the alarm before you start fighting the fire. Pull an alarm, sound a horn, or yell.
- Never go through a fire there is always another route. Use your head and stay calm.
- Act efficiently, time is very important.
- If possible, fight the fire the upwind side; the captain may maneuver the vessel appropriately.
- Never open a door if smoke is coming out of it. Backdraft may occur. Signs of potential backdraft situations:
 - Blackened windows
 - Very little or no flame (depleted oxygen)
 - Smoke leaving a compartment in intermittent puffs (pressurized smoke)
 - A confined space that is generating lots of heat
 - An inward rush of air when an opening is created (e.g. opening a watertight seal). Don't smash windows.
- Use the right extinguisher (Class A, Class B, Class C, etc.) but know the limits. For example, don't use water on an electrical fire (de-energize it) and have another extinguisher ready if the fire is large. Axes and fire buckets will be available on larger vessels.
- Work as a team. Aim low and use sweeping motions. Combat the fire at its origin.
- Never turn your back on a fire. Back away.

Oxygen levels in air will be depleted rapidly in the presence of fire. Crew and passengers should be monitored closely for lack of oxygen.

6.1 Extinguisher Types

In general, the number of extinguishers on board depends on the size of the vessel and its use. Extinguishers can be fixed/piped or portable and are required to be Transport Canada certified.

When using fixed systems important things to remember include turning off equipment and closing ventilation, watertight doorways, and ports. There is only one chance to prep an area before initiating the system. Let the area cool off before entering.



Water (Buckets or pressurized)

Portable - Easy to carry and use. Great for use on combustible fires; paper, wood, etc. When loaded with anti-freeze can be used on some “Class B” fires and on burning rubber.

Water based systems are often found in accommodation and machinery areas. The system is generally charged with fresh water to prevent corrosion but salt-water is supplied by pump. These systems are only used when portable extinguishers have not put out the fire.

Foam

For use on oil fires. Can be used on “A” fires but **never** on “C”. Effective in sealing in flammable vapours and preventing re-ignition.

Foam based fixed systems can incorporate low expanding (e.g. 5:1) chemicals or high expanding (500:1) specialty foams to combat fires.

Carbon Dioxide (CO₂)

Portable and Fixed - Clean, non-toxic, leaves no residue. Effective on Class “B” and “C” fires. Only to be used on short range fires that will not be affected by wind/breeze.

Dry Chemical

Portable and Fixed - Usually sodium bicarbonate (baking soda) mixed with a waterproofing agent. Leaves residue but good on longer range fires and not as affected by wind.

Potassium Bicarbonate (Purple K)

Portable and Fixed - Twice as effective as sodium bicarbonate. Used in the same situations as dry chemical. Very effective on longer range fires and reduces the dangers of re-ignition. Often used in galley kitchens.

ABC Chemical

These extinguishers can be effectively used on Class A, B, and C fires. This type of chemical (monoammonium phosphate) is multi-purpose.

7.0 LIFESAVING EQUIPMENT & ABANDONMENT

7.1 Life jackets and flotation devices

Life jackets and personal flotation devices (pfd) come in many different types and colors, and Canadian vessel regulations will specify minimum requirements for flotation devices depending on the type of vessel.

All life jackets and pfds must be approved by Transport Canada, the Department of Fisheries and Oceans, or Canadian Coast Guard. This approval is a stamp or label on the inside of the flotation device. Flotation devices only approved by the U.S. Coast Guard are *not recognized* in Canadian Waters. Canadian-approved flotation devices are listed under the *Approved Products Catalogue Index* (<http://wwwapps.tc.gc.ca/saf-sec-sur/4/apci-icpa>).

The Transport Canada Marine Safety 3 approved colors are: RED, ORANGE, and YELLOW.

Flotation devices must be maintained and in good working condition in order to be Transport Canada approved. Those that are torn, missing parts, or generally in poor condition are not approved.



You must know the difference between life jackets and pfds. Life jackets keep your head above water, while pfds assist with floatation but do not keep your head above water specifically. See section 7.1.1 and 7.1.2 below.

7.1.1 Life jackets

All commercial vessels in Canada must have life jackets available for all crew and passengers. These are designed to orient a conscious/unconscious person face up in the water. They provide extra buoyancy (> 15.5 lbs of floatation), but are uncomfortable to wear and are thus preferable for abandon ship situations. There are three types of life jackets and they come in different sizes relative to the Dry Weight of the person using it (Table 2).

Table 2: Types of Canadian approved life jackets for commercial vessels

Type of life jacket	Performance in water	Sizes	Description
---------------------	----------------------	-------	-------------

<p>Standard life jacket</p>	<p>Slowest performance, turns you on your back to keep your face out of the water, but may do so more slowly. The vest-style are comfortable to wear and offer some thermal protection</p>	<ul style="list-style-type: none"> - Over 40 kg (88 lbs) - Less than 40 kg (88 lbs) 	<p>Keyhole</p> 
<p>Small Vessel Regulation life jacket</p>	<p>Slower performance, turns you on your back to keep your face out of the water</p>	<ul style="list-style-type: none"> - Over 41 kg (90 lbs) - 18 kg (40 lbs) to 41 kg (90 lbs) - Less than 18 kg (40 lbs) 	<p>Keyhole or Vest</p> 

SOLAS life jacket¹	Highest performance, turns you on your back in seconds to keep your face out of the water	<ul style="list-style-type: none"> - Over 32 kg (70 lbs) - Less than 32 kg (70 lbs) 	Keyhole
			

7.1.2 Personal Flotation Device (PFD)

Personal flotation devices (PFD) are generally preferable to wear continuously while onboard a vessel because they are comfortable, however, they are not approved for use on commercial vessels, unless an approved life jacket (Section 7.1.1) is available for each person in addition to the PFD. A life jacket must be within reach and donned in emergency situations, instead of the PFD.

PFDs are more comfortable to wear and provide some thermal insulation, but they have less buoyancy (15.5 lbs) than life jackets and *do not right a conscious/unconscious person face up in the water.*

PFDs do not have neck and head support.



Type of pfd	Description	Pros	Cons
Life vest	Vest with adjustable straps for fitting.	<ul style="list-style-type: none"> - Offer thermal protection and can include utility-functions specific to a water activity (kayak, swiftwater, work vest) 	<ul style="list-style-type: none"> - Can be difficult to exit if entrapped in an enclosed hull under water following a capsizing due to buoyancy.

¹ Safety of Life at Sea: The highest international certification issue to a Personal Lifesaving Appliance

		- Always buoyant	
Inflatable (automatic) pfd	Horse-collar type with CO2-cartridge that inflates upon contact with water. Also includes a pull handle for manual inflation, and a mouth piece to manually inflate.	<ul style="list-style-type: none"> - Automatically inflates when falling overboard, and therefore buoyant instantaneously. - Least bulky pfd to wear. 	<ul style="list-style-type: none"> - May inflate accidentally in wet weather conditions or when working with water. - Releases air over long time exposure. - Can be difficult to exit if entrapped in an enclosed hull under water following a capsizing due to buoyancy. - Trigger release mechanism may fail.
Inflatable (manual) pfd	Horse-collar type with a pull handle for manual inflation and a mouth piece to manually inflate.	<ul style="list-style-type: none"> - Manual control of inflation provides an advantage if entrapped in an enclosed hull under water following a capsizing 	<ul style="list-style-type: none"> - Does not automatically inflate and can be difficult to use in a panic situation. - Releases air over long time exposure.
Inflatable (hydrostatic) pfd	Horse-collar type with CO2-cartridge that inflates only at a certain depth of water (pressure-triggered).	<ul style="list-style-type: none"> - Automatically inflates when falling overboard, and therefore buoyant instantaneously. - Least bulky pfd to wear. 	<ul style="list-style-type: none"> - Can be difficult to exit if entrapped in an enclosed hull under water following a capsizing due to buoyancy. - Trigger release mechanism may fail.
Floater coat/suit (Mustang survival suit)	Clothing style jacket or one-piece suit to be worn on top of clothing.	<ul style="list-style-type: none"> - Best thermal protection in cold marine environments. 	<ul style="list-style-type: none"> - Can be difficult to exit if entrapped in an enclosed hull under water following a capsizing due to buoyancy.

7.2 Immersion suits

Immersion suits are often called Survival suits, but this incorrectly refers to Mustang floater coats and suits.

Immersion suits are designed to offer the best protection in cold temperatures, if donned properly. They keep you dry, insulated against cold, and floating on your back to allow free breathing passage. Immersion suits are very bulky to wear, and should only be worn when preparing to abandon ship and in the water. Often vessels provide only one-size-fits-all which is extra bulky for smaller persons but they still function adequately in keeping water out of the suit as the seals around your face area universal. Some suits have a buddy line to attach to a floating object (i.e. life raft) or each other to remain in a group.



Not all vessels are required to have these and it will depend on the working environment and vessel classification. Only Transport Canada approved immersion suits are to be used in Canada. If required on the vessel, it is mandatory to have one for each crew and passenger onboard.

As part of training and emergency drills, you should know how to don these suits in less than 60 seconds. That includes:

- Retrieving your suit bag from storage
- Going to an open space to begin putting it on (Muster Station)
- Remove your footwear
- Place your legs in the pants and then the arms in the sleeves
- Bend over to put on the hood, then straighten your back up
- Close front zipper slowly but firmly
- Adjust the face adjustment straps
- Put on the gloves
- Do a Buddy-check on surrounding people to ensure their zipper is done up all the way and that their face straps are adjusted.
- Avoid jumping into the water until directed to do so. If jumping, cross your legs and place one hand over your face.
- You can swim in the suit when on your back.

7.3 Life buoys

Life buoys are floating rings that will assist a person in keeping afloat. Life buoys are intended to be thrown into the water for a “Man Overboard”. More than one person can hold on to a life ring.

In Canada, only rings are approved. They have reflective tape, and are surrounded by a perimeter of floating yellow line to assist in holding. The vessels name and port of registry shall be displayed.

Life buoys (also known as Life rings) should be accessible on the vessel on both sides and from bow to stern. The number of life buoys that a vessel requires depends on the vessel size and crew size.

Life buoys can also come equipped with floating heaving line (line that floats), a self-igniting light, or a self-igniting smoke signal attached to the ring.



7.4 Life rafts, emergency boats and equipment.

7.4.1 Life raft

Vessels of a certain size are required to carry one or more life rafts situated outside the vessel. Life rafts are intended as last resort for “Abandon Ship”. Many lives have been lost because people abandon ship too late or too soon. It is the Captain’s authority to order “Abandon Ship”, and you may only choose to do so if the Captain is unable to give the command. You must then choose to “Abandon Ship” individually and wisely.

A capsized or compromised vessel remains your most stable ground until it becomes unsafe and your last resort should then be to enter the life raft. The life raft should be deployed and ready to go until this moment becomes necessary. The life raft is for survival when no other option is available.

Inflatable life rafts are the most common type of life raft and is designed to inflate once the painter line is withdrawn during automatic or manual launching. The painter line is attached to the vessel and the hydrostatic release on the painter line requires a pull or pressure to release. The painter line can be pulled with force to manually inflate the raft. On a sinking ship going below the surface (3 m), the buoyant life raft canister will pull against the painter line and automatically inflate.

Deploy the life raft on the leeward side of the vessel. Avoid launching into the waves or the wind. If the life raft deploys right side down, or capsized by wind or waves during launching, it must be righted physically. Climb onto the floor of the raft, hold onto the line running across the floor, and stand on the gas canister. Lean back towards the water on your back and the gas canister and your body weight will cantilever the raft right side up. The raft may land on top of you, but is light and you can swim your way from beneath it. The life raft will have a ladder to climb into it.



Remain with the life raft. A person hanging on to a life raft is more easily spotted than a person floating on their own. Do not abandon life raft and attempt to swim to shore unless you are certain you can make the crossing. Distances are often underestimated on the water.

7.4.2 Emergency Boats

Vessels may choose to have an emergency or a tender boat/skiff that is more commonly used in day to day operations and under average sea conditions. They are small vessels best suited for sheltered waterways.

In Canada, they must be equipped with the following mandatory safety equipment:

- Fire fighting equipment (extinguisher, buckets)
- Navigation equipment (sound signal [whistle, air horn, bell], navigation lights, compass)
- Visual signs (watertight flashlight, flares)
- Vessel safety equipment (anchor, bilge pump)
- Personal lifesaving appliances (lifejacket/PFD, buoyant heaving line, lifebuoy, and reboarding device)
- Paddle
- Knife

7.4.3 Survival Equipment

Commercial vessels will carry additional survival equipment. These may include any of the below listed items.

- EPIRB (Emergency Position Indicating Radio Beacon)
- Ship-mounted and handheld VHF radios
- Flares [parachute, multi-star, hand-held, or smoke]
- Emergency food and water rations
- Emergency blanket
- Knife
- Air signalling horn and whistles
- Watertight flashlight/signalling lamp
- Whistle
- Anchor
- Paddle
- First aid kit
- Buoyant heaving line/throw bag



7.5 Survival

7.5.1 Factors relating to survival

Initial Immersion and Cold Shock

An individual's response to cold water will vary depending on a number of factors including clothing/insulation, amount of body fat and activity, but the steady decline in core temperature will continue until after the person is removed from the water. Dependent upon how long the victim is in the water hypothermia may be an issue and careful treatment of the patient may be required to minimize the risk of cardiac arrest. In arctic waters an individual can lose dexterity in only a few minutes. When exposed to cold water (<21 °C) in the face, people may also experience the immediate "Cold Water Gasp" reflex. Submersion in cold water causes an automatic gasp to breathe in a large volume of air which may lead to inhalation of water and drowning. Wearing a PFD when in the water will bring you to the surface and keep you on the surface as you are gasping or choking.

Short-term Immersion and Swim Failure

Swimming in cold waters while wearing bulky survival gear can be exhausting. In order to conserve energy and reduce water movement around the body avoid swimming unless necessary. The less percentage of your body exposed to cold, the less heat you will lose.

Long-term Immersion and Hypothermia

Without thermal protection the body will lose heat up to 25 times faster in water than air. This can be compounded with swimming or moving water. Maximum thermal protection is best for surviving immersion in cold water (i.e. Immersion suit with warm layers beneath)

In Arctic waters hypothermia (reduced body core temperature) can occur in less than 10 minutes.

Hypothermia can be divided into Mild, Moderate and Severe stages. These stages are defined by the "State of Alaska Cold Injuries Guidelines for Wilderness Emergency Care". The following chart lists the signs and symptoms used in the classification of these three stages.

Classifications of Hypothermia	Core Body Temperature	Patient's ability to rewarm without external heat source	Clinical presentation of Hypothermic Patient	
Normal	Above 95°F 35°C	N/A	Cold sensation shivering	
Mild	95-90°F 35-32°C	Good	Physical impairment • Fine motor • Gross motor	Mental impairment • Complex • Simple
Moderate	90-82°F 32-28°C	Limited	Below 90°F (32°C) shivering stops Below 86°F (30°C) consciousness is lost	
Severe	Below 82°F 28°C	Unable	Rigidity Vital signs reduced or absent Severe risk of mechanically stimulated ventricular fibrillation (VF) (rough handling)	
	Below 77°F 25°C	Unable	Spontaneous ventricular fibrillation (VF) Cardiac arrest	

(Source: <http://www.coldwaterbootcamp.com/pages/preventionv2.html>)

If someone has suspected hypothermia get them to medical treatment immediately. Treat the patient with care to avoid heart related medical emergencies. Lie the patient down, remove wet clothing, and use blankets to over them. Heat should only be applied to heat transfer areas such as armpits, inner thigh / groin, or sides of the chest. In moderate and severe hypothermia cases the patient should not drink or eat or sit up until stable for 30 minutes. Do not place patients into warm baths.

7.5.2 Actions to increase chances of survival prior to rescue

STOP!! Stop panicking, Think, Observe your surroundings, and Plan your next move.

If possible, deploy the EPIRB signal or call other ships in the area on a VHF radio

Stay afloat. After removing yourself from any hazards (burning debris, sinking objects, overhead hazards) the priority is to find floatation. This could be a life raft or piece of foam or floating debris. Get to it and stay with it. In rough waters protect your face and turn away from wind to allow easier breathing.

Get as much of your body out of the water as possible and do not drink salt water.

Position your body to lessen heat loss. Use a body position known as the Heat Escape Lessening Position or Posture (think H.E.L.P.) to reduce heat loss while you wait for help to arrive. Just hold your knees to your chest; this will help protect your torso (the body core) from heat loss. Another option is to huddle together in a tight circle and hold on to each other and remain still.

8.0 SIGNALING

8.1.1 Recognition and operation of signaling devices including pyrotechnics

Visual signalling devices and options can include arm movements, flares, flashlights, dyes, whistles, bells, air horns, gun shots, mirrors, search and rescue transponders, or flags. Vessel crew members will be trained to access and deploy emergency and distress signalling devices.

An option for visual and auditory signalling includes using Morse Code and SOS (three short, three long, three short).

8.1.2 Electronic communication

In modern times electronic signalling can take many forms. In most parts of Canada cellular networks are readily available for communication. In arctic waters these networks are not an option. Electronic communication devices other than cell phones include boat radios (HF and VHF), satellite phones and messengers, EPIRB, Morse Code and radio communications are very useful in emergency situations. The international VHF channel for emergency signalling is VHF Ch. 16 (156.8 MHz) and repeating the words May Day, May Day, May Day for immediate danger and Pan-Pan, Pan-Pan, Pan-Pan for urgent messages will notify nearby vessels.

Radio distress calls should include:

- Location of vessel or emergency
- Name of the vessel

- Nature of problem (engine seized, capsized, taking on water, medical issues, etc.)
- The number of people involved
- Any plans for abandonment

The biggest downfall of VHF is broadcast range. The signal is limited by the curvature of the Earth. Antenna height plays a big role here, as can atmospheric conditions. With an average fixed-mounted antenna height on commercial, you can't expect a range much over 30 km. The range of a handheld radio is much less (5 km at most).

DSC (Digital Selective Calling) equipped radios are common on vessels. When triggered the Coast Guard will automatically get the exact GPS position, they'll know you're sending a distress call, and they'll know who you are.

9.0 RESCUE EQUIPMENT AND METHODS

Search and rescue services and equipment can vary, including helicopters and vessels. Cougar search and rescue slings and Cougar search and rescue baskets are commonly used from a helicopter during rescue situations. A MARSARS cold water rescue sling and SECULIFT rescue sling are typically used for rescues from smaller vessels. Each of the four methods are also used from larger vessels.

Cougar search and rescue slings are the basic hoisting tools used on an individual being hoisted for immediate extrication. This can be completed by hoisting the individual independently or via a double up method with a rescue man as well.

Cougar search and rescue baskets allow for hoisting a person who may be incapacitated from the water. The basket also can be used as a rapid evacuation method from a vessel if needed.

A MARSARS cold water rescue sling and ECULIFT rescue sling is a versatile device that the rescuer extends by hand from a safe distance to the individual. The individual must be able to assist in their own rescue with this method as they must be able to place the sling around themselves. The rescuer then pulls the individual to the boat, taking care to not also be placed at risk. The devices can also be used in ice rescue operations.

AMR/

APPENDIX B

Species Identification

1.1 Species Identification

Identifying the species of marine mammal you have observed is a task that is learned through training and experience. If you are local to the area, you likely already know more than we do!

If you are unsure about what species you have spotted you can ask others on the bridge to help you identify the animal, including the other MMO on the bridge and the Golder lead. It is also a good idea to take a photo as soon as you see the sighting. Photos can be useful to confirm species identification. Marine mammal cues can sometimes look different from an elevated surface like that of the bridge of a large vessel compared to from smaller vessels at the water surface. It may take a few sightings to get used to cues from a different platform. If you still do not know the species and the sighting has disappeared, then you would simply record the sighting as unidentified and mark it as a possible species identification.

The common marine mammals in the area include:

- narwhal whales
- beluga whales
- killer whales
- bowhead whales
- ringed seals
- harp seals
- bearded seals
- walruses
- polar bears

Here are some helpful hints to distinguish between the common marine mammals you are likely to see in the area.

1.1.1 Whales

If you spot what you think is a whale the first questions to ask are:

- what is the shape of the blow?
- what is the size of the whale?
- what is the colour?
- do you see a tusk?

If it is a large whale with a V-shaped blow then it is likely a bowhead whale. If it is smaller with a lower bushy blow and white then it is likely a beluga whale. If it is smaller with a lower bushy blow and dark then it is likely a narwhal whale. If it is smaller with a lower bushy blow and a large dorsal fin then it is likely a killer whale.

Narwhals



Adult male narwhals are easily recognizable by their long spiraled tusk that can extend up to nine feet. Narwhals do not have functional teeth inside the mouth, but males (and some females) continuously grow one of two upper jaw teeth through their lips. The narwhal is a relatively small whale (4.7 m) with a sleek grey and white spotted body. Their head is blunt lacking a beak, and they lack a dorsal fin. The pectoral flippers are small and rounded, and their fluke is noticeable convex at the terminal end. They occasionally lift their flukes while diving. Narwhals follow the receding Arctic ice in the summers deep into

non-frozen pockets of bays and fjords, and migrate out to sea as winter ice grows. Light colored females and calves can sometimes be mistaken for belugas, but generally a few individuals in a group of narwhals will display identifiable characteristics. Large congregations of hundreds of animals occur in the summer months.

Beluga Whales



As the only marine mammal that is completely white, the beluga whale is easily recognizable. Its skin can at times have a yellowish-tint. Belugas have a relatively small body size (as with the narwhal) of between 2.7 to 4.2 m long. The head is blunt, containing a protruding melon. Their fins are small and they have narrow ridge instead of a dorsal fin. They rarely raise their flukes when diving. Belugas are very social, often found in groups or 5 to 15 individuals and even aggregations of thousands in some estuarine and bays. They display a strong site fidelity to their natal bays. They can sometimes be

mistaken for young harp seals, ice or white birds.

Killer Whales

Killer whales will be the only whale you may see with a prominent dorsal fin. They are mid-sized whales (larger than narwhals and belugas) and can reach up to 9 m in length. Their other distinguishing feature is their dark black bodies with white eye and saddle patches. It should be easy to spot and identify killer whales if they surface during the program.



Bowheads

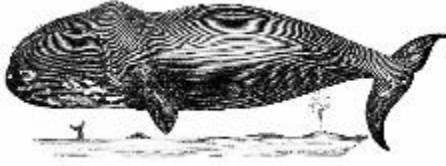

The Bowhead has black robust body, lacking a dorsal fin, a massive head, and a highly arched jaw line. Distinguishing features are a white lower chin patch and a hump anterior of the blowholes followed by a depression. The immense head is capable of breaking through

ice 1.8 meters thick. Their blows are also V-shaped when seen from the front or from behind, and they often raise their fluke when diving. They are closely associated with sea ice and follow the receding ice in the northern hemisphere summers.



1.1.2 Seals and Walruses

Ringed Seals

Ringed seals are the smallest and most common species of seal in the Arctic. They are the most important prey species for polar bears. Ringed seals have plump bodies and small heads with short snouts. They are generally dark dorsally with irregular ring patterns and lighter on the ventral side. Pups are born white and shed this coat at 6 to 8 weeks of age after which they are uniformly dark until their first molt. Like the bearded seal, they are also closely associated with sea ice. Ringed seals are also often observed alone and do not often aggregate in large groups. Ringed seal molt in June and July when they haul-out on the sea ice.



Harp Seals

Harp seals are distinguishable from ringed seals in their horseshoe-shaped dark saddle patch on their backs. Pups are born with white fluffy coats until 3 to 4 weeks of age when the white coat is replaced with a silver coat with some scattered spot. Adult have robust bodies and small heads with broad flat narrow snouts. They have light gray coats with black faces and black saddle patch. Younger individual may appear spotted as their saddle patch develops with each moult. Aggregations are observed during breeding (February to March) and in spring when moulting. Groups may also form during feeding and migrating activities.





Bearded Seals

Bearded seals are one of the largest seals in the Arctic. Its distinguishing characteristic is a dense “beard” of whiskers on its upper lip. Its large body is offset by its small blunt head with large cheeks. The square fore flippers are small relative to the body making it appear more stocky and robust than other seals. Adults are gray or dark brown with some spots or rings visible. Pups are also brown to bluish. Bearded seals are generally associated with drifting sea ice in shallow-water areas. They are more commonly observed alone, however, aggregations may occur when drifting sea ice becomes concentrated. During the months of April to August bearded seals will spend more time hauled out for molting.



Walrus

Walrus are easily distinguished from other seals by their large bodies and tusks. They have a thick bunch of whiskers on their cheeks. Adult males are usually much larger than females. Skin colour varies and can appear pale beige to bright pink. Newborns have greyish-brown hair. In the summer, walrus haul-out on pebbly and sandy beaches in large aggregations to molt and rest.

1.1.3 Polar Bears

Polar bears are easily distinguishable from other marine mammals. On the ice, polar bears appear to have a yellow-tint. Keep in mind that you may observe a polar bear swimming in the ocean. Its pointed snout should allow you to distinguish it from seals.



APPENDIX C

**Golder Guideline and Directive -
UAV**



1.0 DIRECTIVE

This Directive and Guideline (D&G) establishes the minimum requirements to work with Unmanned Aerial Vehicles (UAV), also known as Unmanned Aerial Systems (UAS). UAV represent a rapidly emerging tool with numerous applications across Golder's service sectors. They also represent a significant legal risk, due to their potential to interfere with air traffic and other sensitive infrastructure. In addition to recognizing and mitigating the hazards of working with UAV, this D&G will provide guidance on Golder's existing UAV management structures, which meets the requirements of Transport Canada, and other legislative considerations when planning a UAV field program.

As legislation is different between countries, this Directive and Guideline is limited to Canada and users should be aware that requirements vary between the five flight regions in Canada (BC, Prairies-North, Ontario, Quebec, and Atlantic Canada).

These guidelines are not intended to conflict with or supersede legislation.

2.0 DEFINITIONS AND ABBREVIATIONS

UAV – Unmanned Aerial Vehicle. Includes fixed wing and multicopters.

Fixed Wing UAV – UAV that flies like an aeroplane. Forward motion is required to stay airborne, can glide in the event of power loss.

Multicopter – UAV which hovers using multiple fixed pitch propellers oriented vertically. Typical multicopters have four propellers and are also known as Quadcopters.

SFOC – Special Flight Operations Certificate. A permit issued by Transport Canada which allows for UAV operations in areas outside of those covered in the UAV exemption.

LiPO – Lithium Polymer Battery. The type of battery typically used by UAVs.

Wh – Watt hour, the measure of power capacity of batteries, used by airlines to determine if batteries can be carried onboard.

SPECIAL FLIGHT OPERATIONS CERTIFICATE

Special Flight Operations Certificates (SFOC) are an agreement between Transport Canada and Golder which allow us to operate UAVs for business, provided we comply with the agreed upon restrictions, and establish the required management structure.

Transport Canada divides the country up into five flight regions (British Columbia, Prairies North, Ontario, Quebec, and Atlantic Canada), each requiring their own SFOC. In addition, because of the different nature of UAV operations, Golder may hold multiple SFOC in the same flight region for different types of UAVs.

Operations Directors and Managers as well as their delegates are authorized to submit SFOC applications. Persons wishing to submit a new SFOC application should contact their nearest Operations Director and Manager. The submitting party then works with Transport Canada to make any requested changes prior to final approval. The entire process can take several months depending on the region and complexity of the application.



A team site has been created which houses all of the SFOCs currently held by Golder in Canada. Projects requiring a UAV component must contact an UAV subject matter expert, also listed on the team site, for guidance on SFOC development and compliance.

3.0 RESPONSIBILITIES AND MANAGEMENT STRUCTURE

3.1 UAV Operations Director

- Oversee UAV operations and ensure compliance with Transport Canada regulations.

3.2 UAV Operations Manager

- Review pre-flight checklists and hazard assessments prior to each flight.
- Verify that pilots are fully prepared.
- Maintain records of training, flights, and any incidents.

3.3 UAV Pilot

- Be familiar with the relevant legislation from Transport Canada, the SFOC which they will be working under and the appropriate UAV operations manual.
- Complete the required training as specified in the UAV operations manual and be cleared by lead pilot as competent prior to flying on projects.
- Maintain competency in piloting UAVs including attending annual refreshers.

3.4 Visual Observer

- Be familiar with the UAV operations manual.
- Receive an operations briefing from the UAV pilot prior to each flight.

3.5 Project Managers

- Review this D&G prior to preparing the project specific Health and Safety, Environmental Plan (HaSEP).
- Review the relevant SFOC.
- Ensure only qualified pilots operate UAVs.
- Ensure a qualified pilot has completed the UAV-specific hazard assessment and pre-flight checklist.
- Ensure the designated visual observer is familiar with the UAV operations manual.
- Co-ordinate with UAV Operations Manager.



- Confirm that the HaSEP identifies all actual and potential dangers including:
 - Distracted drivers operating equipment or vehicles in the area
 - Sensitive receptors
 - Wildlife
 - Conflicting air traffic
- Delegate responsibility as necessary to the site supervisor during field work.

3.6 Employees

- Do not enter the area of the UAV survey, or walk under a UAV.
- Review and follow all applicable instructions and controls contained in the project HaSEP and FLHAs.
- Participate in all pre-flight meetings.
- Report all hazards, near misses and incidents to the site supervisor as soon as possible.

4.0 GUIDELINES

4.1 Hazards and Controls

HAZARDS: Choosing from the list below, identify in your project HaSEP the hazards that could be present on your worksite.	CONTROLS: According to your identified hazards, add to the HaSEP, the appropriate controls that you will implement on your project worksite. Suggested controls may be found in the list below or you may need custom controls for your project that provide a greater degree of safety.
Person or Equipment struck during takeoff and landing	Administrative Controls <ul style="list-style-type: none"> ■ Take off and land from a level surface. ■ Alert all personnel in area prior to take off and landing. ■ Do not take off or land closer than 3 m to people or equipment. ■ Review UAV emergency response plan and complete pre-flight checklist/hazard assessment prior to launch. ■ Check GPS link strength prior to launch. PPE <ul style="list-style-type: none"> ■ Hard hat, safety glasses.
Other aircraft struck during flight	Administrative Controls <ul style="list-style-type: none"> ■ Certified UAV pilot to complete a pre-flight hazard assessment including determination of airspace class.



CANHSE255 - UNMANNED AERIAL VEHICLES (UAV)

	<ul style="list-style-type: none">■ Monitor appropriate radio frequency as required by region during flight.■ Visual observer and assistants scan sky for other aircraft so that pilot may give way.■ Check for alternate airborne activities (paragliding, parasailing, kites etc.).
Equipment malfunction during flight resulting in crash landing Equipment malfunction during flight resulting in fly-away	Administrative Controls <ul style="list-style-type: none">■ Inspect UAV prior to and after each flight as outlined in pre and post-flight checklist.■ Never fly over people or sensitive equipment.■ Maintain visual contact with UAV and keep ABC fire extinguisher accessible to allow for rapid response in event of crash.■ Maintain appropriate controls over project area to prevent unintended access by personnel/public/equipment.■ Non-essential personnel must be 100 feet away.■ Review UAV emergency response plan and complete pre-flight checklist/hazard assessment prior to launch.■ Follow fly-away emergency procedure from SFOC application.■ Check GPS link strength prior to launch.
Distraction of equipment operators/drivers	Administrative Controls <ul style="list-style-type: none">■ Alert equipment operators in area prior to commencing operations.■ In areas adjacent to public road ways, consider using traffic control such as flaggers and signs.
LiPO battery charging (fire)	Administrative Controls <ul style="list-style-type: none">■ Examine LiPO prior to charging for damage and signs of puffing.■ Do not charge damaged or puffed batteries.■ Keep ABC fire extinguisher accessible when charging.■ Charge batteries in LiPO bags in the event of fire.■ Never charge un-attended.■ Only use chargers specified by manufacturer.■ Store LiPOs at 50% charge, in a case where they are secure from shorting.



CANHSE255 - UNMANNED AERIAL VEHICLES (UAV)

	<ul style="list-style-type: none">■ Do not charge excessively hot or cold batteries.■ Use “smart” batteries when available, or programmable LiPO charger when not.
Airline travel	<p>Administrative Controls</p> <ul style="list-style-type: none">■ UAV and batteries must be carried on, as per regulations for Lithium batteries.■ Use of LiPO bags when transporting via air.■ Small LiPO batteries <100Wh, like those used in UAVs must be carried on and must not be checked.■ Check IATA regulations and with the specific air carrier for the limitations on size and quantity of batteries that may be transported.



4.2 Emergency Response Plan

The following emergency response plan was taken from the BC region multicopter program and is presented as a guideline. Procedures may vary slightly between flight regions and UAV types and should be confirmed for each project.

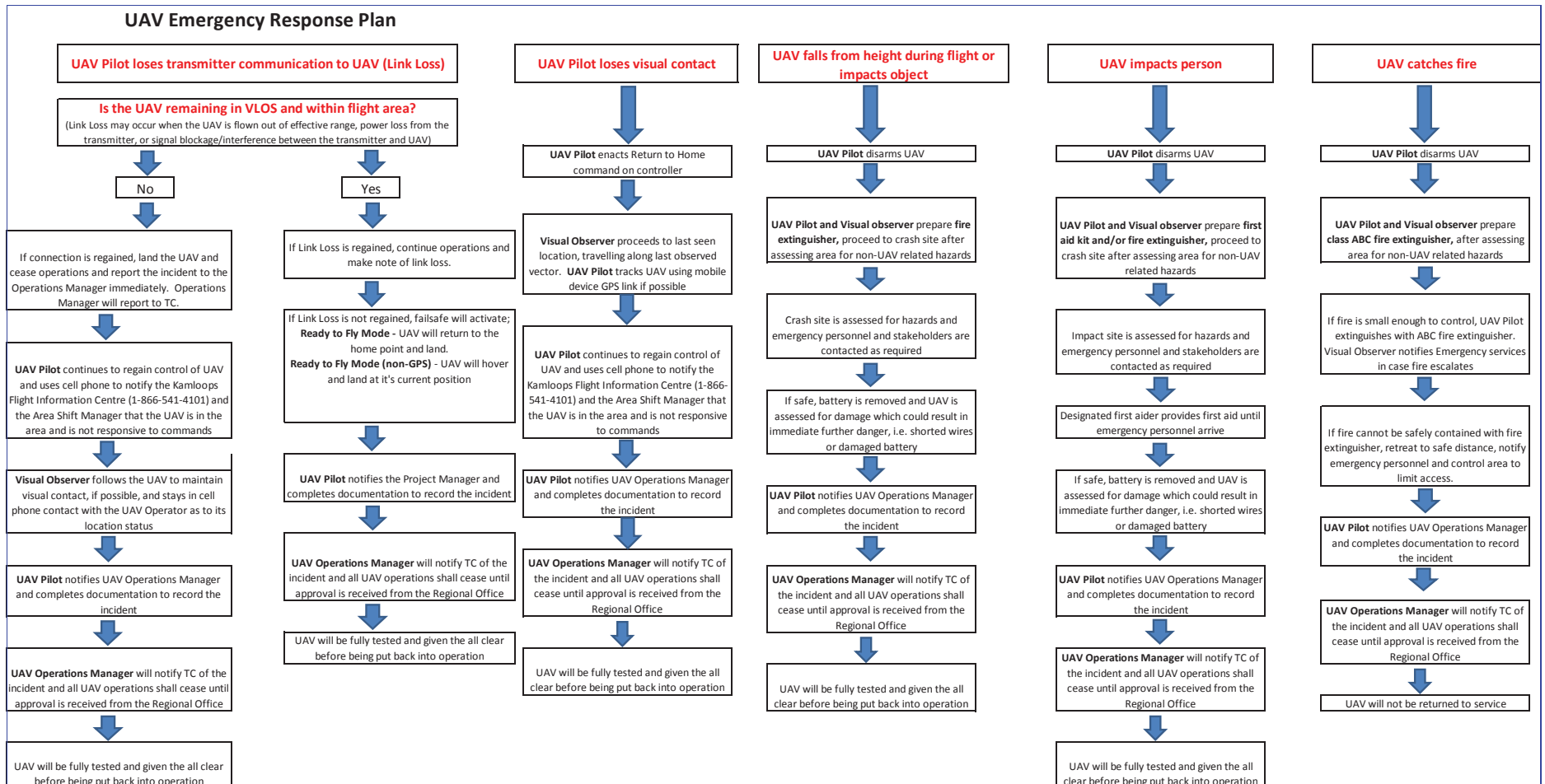



4.3 Flight Planning

- Prior to any operations, the UAV pilot and visual observer will review the VFT Navigation chart and Canada Flight Supplement (CFA) to determine if there are any special requirements or restrictions for the area of operation.
- Operations not occurring during daylight hours, below 300' AGL, and in Class G airspace will likely require coordination with Transport Canada (CAOPAC-OACpac@tc.gc.ca) prior to commencing.
- The Multicopter UAV Operator will determine the Flight Information Region (FIR) they will be operating within and record the contact number of the FIR in their HaSEP. The FIRs are listed on the UAV information groups through Office 365.
- Complete pre-flight checklist and specific Work Instruction for each flight (see specific UAV Operations Manual).
- Obtain land use permission from land owner prior to flight.
- Charge batteries prior to travel to launch site.

4.4 Hazard Assessment and Operations

- Power supply (battery) will be disconnected when the UAV is not in use.
- Check flight plan before launching the UAV identify any obstacles within the planned flight path and determine appropriate hazard controls.
- Operation in fair weather only: maximum wind speed of 15.5 knots (28.7 kph), no operations in heavy rain and snow or icing conditions, temperatures between -10°C and 40°C and operations in good light only.
- Operations will be limited to 300 ft AGL (90 m), with cloud ceilings a minimum of 100 ft (30 m) above the highest planned altitude, and 1 statute mile visibility for minimum weather and daylight hours.
- Weather conditions will be monitored during the course of flight and the UAV will be recalled if conditions change. Given the limited range of operation, conditions are not expected to differ between launch, survey and return to launch paths.
- UAVs will not be used to transport cargo; however, the security and balance of any photographic/video equipment will be checked prior to each flight.
- At no time will a UAV be used for carriage of dangerous goods.
- A safe launch and landing zone will be chosen at least in diameter 100 ft (30 m) and clear of trees, buildings, and roads or other transportation corridors unless traffic control is in place and permission has been granted by the road/rail operator.
- The launch/landing zone will be within line-of-sight contact with the flight area.



- A visual observer will assist with observing and monitoring the flight such as monitoring the airspace and landing zone (e.g. for other traffic, people, obstructions, weather).
- Only essential crew members for the operation of the UAV will be within 100 ft (30 m) of the UAV at any time. Non-essential crew members and anyone else will be kept at a minimum safety distance of 100 ft (30 m) away from the UAV:
 - The crew will visually inspect the area and if there are any people within 100 ft (30 m) they will be notified of UAV operations and request they stay back a minimum of 100 ft (30 m), the crew may decide to use flagging tape to mark the area off if they feel it is required.

5.0 TRAINING

Proximity to Hazard	Learning Level	Learning Component
<p>Working with:</p> <ul style="list-style-type: none"> ■ UAV pilot/operator ■ Visual Observer 	<p>Competent</p> <p>Uses or applies knowledge of the hazards, risks, controls. Puts theory into practice.</p>	<p>Comply with pilot requirements detailed in SFOC. UAV pilot must be familiar with Transport Canada TP 15263 legislation and SFOC and have been cleared by lead pilot for competency operating UAVs.</p> <p>Visual observer must be familiar with UAV operations manual and have received instruction from pilot.</p>
<p>Working Around:</p> <ul style="list-style-type: none"> ■ Other site employees 	<p>Awareness</p> <p>Needs to be aware of the hazard and its risks.</p>	<p>Briefing from UAV pilot prior to commencement of operations.</p>

6.0 SAFETY EQUIPMENT

6.1 Personal Protective Equipment (PPE)

Safety glasses, high visibility vests and hard hats in addition to any other site-specific PPE.

6.2 Additional Equipment

ABC Fire extinguisher as part of UAV field kit.

LiPO fire containment equipment.



VHF Aviation band radio as required by air space class and specific flight operations.

7.0 REFERENCES AND DOCUMENTS

Canadian Aviation Regulations

Canadian Airspace Handbook

UAV Operations Manual – Fixed Wing

UAV Operations Manual – Multicopter

Relevant SFOC

Fish and Wildlife Act

8.0 REVISION HISTORY

Revision	Change(s) Made (Section reference)	Change(s) Made By	Date (mmm yyyy)
1.0	Developed	Barb Edwards/ Ryan Preston/ Steve Kogon	Mar 2016
1.0	Released for Trial	Barb Edwards	Sep 2016

APPENDIX D

Hard Copy Datasheets

Date: _____

Bruce Head Marine Mammal Monitoring 2018
 Vessel Passages and Other Anthropogenic Activities

1663724-11000

Page: _____ of _____

Start/End Time (24-hrs)	Vessel Sighting ID ¹	Distance to Vessel (m)	Radial Angle to Vessel sighting	General Description of Travel	Vessel Class				Observer / Recorder	Description of Vessel (eg. Name, photos)	Description of Hunting Activity (eg. Target species, 3 of shots fired, time of shots)
					<50 m	50-100m	>100 m	Other ²			
____ : ____ ____ : ____											
____ : ____ ____ : ____											
____ : ____ ____ : ____											
____ : ____ ____ : ____											
____ : ____ ____ : ____											
____ : ____ ____ : ____											
____ : ____ ____ : ____											
____ : ____ ____ : ____											

1 - Re-use the same number if the same vessel is sighted again

2 - Helicopter (H), Airplane (A), Kayak (K)

Record during every RAD/ Group Composition and Behaviour Survey, every half hour, and whenever conditions change								
Time (24-hr)	Observer / Recorder	Ice Cover (%)	Precipitation ¹	Cloud Cover (%)	Glare ²	Sea State	Sightability ³	Comments
__ : __					N, L, M, S		E, G, M, P, I	
__ : __					N, L, M, S		E, G, M, P, I	
__ : __					N, L, M, S		E, G, M, P, I	
__ : __					N, L, M, S		E, G, M, P, I	
__ : __					N, L, M, S		E, G, M, P, I	
__ : __					N, L, M, S		E, G, M, P, I	
__ : __					N, L, M, S		E, G, M, P, I	
__ : __					N, L, M, S		E, G, M, P, I	
__ : __					N, L, M, S		E, G, M, P, I	
__ : __					N, L, M, S		E, G, M, P, I	
__ : __					N, L, M, S		E, G, M, P, I	
__ : __					N, L, M, S		E, G, M, P, I	

¹Rain, fog, snow, or none

²None (N), Light (L), Moderate (M), Severe (S)

³Excellent (E), Good (G), Moderate (M), Poor (P), or Impossible (I)

Date: _____
 Survey #: _____ of _____

Bruce Head Marine Mammal Monitoring 2018
 UAV Observation - Team 2

1663724-11000

Survey Start Time: _____															# of pages for this survey: _____			Observer / Recorder: _____												
Sighting #: If a resighting, please reuse the original sighting #. Animals that linger should be resighted every 10 min.															Adult			Juvenile						Primary (1) / Secondary (2) Behaviour			Unique Behaviour	Comments (i.e Photo range)		
Time (24-hrs)	Study Area	Sighting #	Distance to marine mammal	Radial Angle to marine mammal	Whale Species ¹	Group size	Compass Travel Direction	Study Area Glare ²	Study Area Sighting ³	Travel Speed	Spread ⁴	Formation ⁵	Yes Tusk	No Tusk	Unknown Tusk	Yes Tusk	No Tusk	Unknown Tusk	Yearling	Calf	Unknown	Travel	Milling	Resting	Social	Reproductive	Foraging		Unique Behaviour ⁶	
___ : ___										S, M, F, -	T, L	L, P, C, N-d, N																		
___ : ___										S, M, F, -	T, L	L, P, C, N-d, N																		
___ : ___										S, M, F, -	T, L	L, P, C, N-d, N																		
___ : ___										S, M, F, -	T, L	L, P, C, N-d, N																		
___ : ___										S, M, F, -	T, L	L, P, C, N-d, N																		
___ : ___										S, M, F, -	T, L	L, P, C, N-d, N																		
___ : ___										S, M, F, -	T, L	L, P, C, N-d, N																		
___ : ___										S, M, F, -	T, L	L, P, C, N-d, N																		
___ : ___										S, M, F, -	T, L	L, P, C, N-d, N																		
___ : ___										S, M, F, -	T, L	L, P, C, N-d, N																		
___ : ___										S, M, F, -	T, L	L, P, C, N-d, N																		
___ : ___										S, M, F, -	T, L	L, P, C, N-d, N																		
___ : ___										S, M, F, -	T, L	L, P, C, N-d, N																		
___ : ___										S, M, F, -	T, L	L, P, C, N-d, N																		
___ : ___										S, M, F, -	T, L	L, P, C, N-d, N																		
___ : ___										S, M, F, -	T, L	L, P, C, N-d, N																		

1 - Narwhal (N), Beluga (B), Bowhead (Bow), Killer Whale (KW)
 2 - None (N), Light (L), Moderate (M), Severe (S)
 3 - Excellent (E), Good (G), Moderate (M), Poor (P), Impossible (I)
 4 - Tight (narwhals within ≤ body width apart) or Loose (>1 body width apart).
 5 - Linear (L), Parallel (P), Circular/Cluster (C), Non-directional line(N-d), None (N).
 6 - Logging (LO), Chase prey (CH), Catch prey (CA), Rubbing/Petting (RU), Rolling (RO), Tusk (TU), Tail slap (TS), Nursing (NU), Mounting (MO), Sexual Display (SX), Bubble rings (BU), Spyhopping (SP), Breaching (BR), Diving (DY)

Date: _____
 Survey #: _____ of _____

Survey Start Time:												# of pages for this survey:			Observer / Recorder:																			
Sighting #: If a resighting, please reuse the original sighting #. Animals that linger should be resighted every 10 min.												Adult			Juvenile			Yearling			Calf			Unknown			Primary (1) / Secondary (2) Behaviour						Unique Behaviour	Comments (i.e Photo range)
Time (24-hrs)	Study Area	Sighting #	Distance to marine mammal	Radial Angle to marine mammal	Whale Species ¹	Group size	Compass Travel Direction	Study Area Glare ²	Study Area Sighting ³	Travel Speed	Spread ⁴	Formation ⁵	Yes Tusk	No Tusk	Unknown Tusk	Yes Tusk	No Tusk	Unknown Tusk	Yearling	Calf	Unknown	Travel	Milling	Resting	Social	Reproductive	Foraging	Unique Behaviour ⁶						
__ : __										S, M, F, -	T, L	L, P, C, N-d, N																						
__ : __										S, M, F, -	T, L	L, P, C, N-d, N																						
__ : __										S, M, F, -	T, L	L, P, C, N-d, N																						
__ : __										S, M, F, -	T, L	L, P, C, N-d, N																						
__ : __										S, M, F, -	T, L	L, P, C, N-d, N																						
__ : __										S, M, F, -	T, L	L, P, C, N-d, N																						
__ : __										S, M, F, -	T, L	L, P, C, N-d, N																						
__ : __										S, M, F, -	T, L	L, P, C, N-d, N																						
__ : __										S, M, F, -	T, L	L, P, C, N-d, N																						
__ : __										S, M, F, -	T, L	L, P, C, N-d, N																						
__ : __										S, M, F, -	T, L	L, P, C, N-d, N																						
__ : __										S, M, F, -	T, L	L, P, C, N-d, N																						
__ : __										S, M, F, -	T, L	L, P, C, N-d, N																						
__ : __										S, M, F, -	T, L	L, P, C, N-d, N																						
__ : __										S, M, F, -	T, L	L, P, C, N-d, N																						
__ : __										S, M, F, -	T, L	L, P, C, N-d, N																						
__ : __										S, M, F, -	T, L	L, P, C, N-d, N																						
__ : __										S, M, F, -	T, L	L, P, C, N-d, N																						
__ : __										S, M, F, -	T, L	L, P, C, N-d, N																						
__ : __										S, M, F, -	T, L	L, P, C, N-d, N																						

1 - Narwhal (N), Beluga (B), Bowhead (Bow), Killer Whale (KW)
 2 - None (N), Light (L), Moderate (M), Severe (S)
 3 - Excellent (E), Good (G), Moderate (M), Poor (P), Impossible (I)

4 - Tight (narwhals within ≤ body width apart) or Loose (>1 body width apart).
 5 - Linear (L), Parallel (P), Circular/Cluster (C), Non-directional line(N-d), None (N).

6 - Logging (LO), Chase prey (CH), Catch prey (CA), Rubbing/Petting (RU), Rolling (RO), Tusk (TU), Tail slap (TS), Nursing (NU), Mounting (MO), Sexual Display (SX), Bubble rings (BU), Spyhopping (SP), Breaching (BR), Diving (DY)



golder.com

APPENDIX B

**Bruce Head Vessel-based Marine
Mammal Monitoring –
Daily Summaries**

**2018 BRUCE HEAD VESSEL-BASED MONITORING PROGRAM
BAFFINLAND PO #4500046008
GOLDER PROJECT 1663724-PHASE 11000**

2018 Bruce Head Program – DAILY UPDATES 01 August – 07 August 2018	
Date	Daily Activities – Field Log
	Field Team - Golder: Mitch Firman (MF); Andrew Rippington (AR); UNB (Golder Sub): Sam Sweeney (SS); Inuit Staff: Adrian Ootoova (AO), Johnny Takawgak (JT)
01-Aug-18	MF/AR – TRAVEL DAY – Victoria to Ottawa. SS – TRAVEL DAY – Toronto to Ottawa. Team members met at Ottawa airport and checked into hotel (Hilton Garden Suites – Airport). Overnight in Ottawa.
02-Aug-18	MF/AR/SS – TRAVEL DAY - Ottawa to Pond Inlet. Arrive at Pond Inlet 18:30. Met with Inuit participants JT and AO that evening to discuss training the next day and program details.
03-Aug-18	MF - MHTO meeting at 09:00, reconnect AIS computer to internet – all working. MF/AR/SS – 10:00 program training session begins with Inuit program participants JT/AO and spares Enook Muckta (EM) and Matthew Mackpa (MM - arrived after lunch). Training ended at 17:00. Project preparations and planning continued until 21:00 (MF,AR, SS)
04-Aug-18	MF/AR/SS/AO/JT – Team meeting at 10:00. Reviewed Health and Safety Plan, training manual, and sightings database. Went over data collection methods and marine safety procedures. Contacted Nuliajuk operator to get an estimated time of arrival. Nuliajuk confirmed they are running late due to ice conditions in Baffin Bay (mobilizing from Labrador). Estimated time of arrival is Aug 06 (mid-day).
05-Aug-18	MF/AR/SS/AO/JT – Team meeting at 10:00. Review updated database. Conducted UAV (drone) testing east of Pond Inlet. Visited local stores for final preparation. Contacted Nuliajuk operator to get an updated estimated time of arrival. Estimated time of arrival is Aug 06 (mid-day).
06-Aug-18	MF/AR/SS/AO/JT – Morning tool box talk – went through FLHA with team members. Check out of Sauniq Hotel. Nuliajuk arrives at 11:30, 14:30 departure from Pond Inlet for Milne Inlet. Vessel orientation provided by Deckhand (Alfred Burton). Tested communications. No H&S incidents. PR notified BIM/Fednav via email that Bruce Head team has boarded vessel and are proceeding to anchorage location at Bruce Head. Additional information also provided with respect to study period, planned UAV surveys, check-ins, and contact info on vessel, communication procedures and HSE information.

2018 Bruce Head Program – DAILY UPDATES 01 August – 07 August 2018	
07-Aug-18	<p>MF/AR/SS/AO/JT – MV Nuliajuk arrives onsite at survey location in Milne Inlet at 00:30. Anchored vessel 600 m east of shipping route (72° 1.279' N, 80° 38.303' W; 85 m water depth). MEEMP team dropped off Big Eyes and satellite phone using MEEMP boat. Bruce Head team begins observations in the AM. Completed 11 hourly RAD surveys. No narwhal observed in survey area (only seals). Observed one group of narwhal with the big-eyes hanging out near point at Bruce Head – group eventually moved into Koluktoo Bay staying close to the head (northern shore). Flew UAV in survey area (test flights as no narwhal in survey grid) – some magnetic interference encountered in UAV compass (likely due to metal on boat) which has impacts on UAV performance. Recalibrated the compass of both drones - only one functional. UAV performance also suggested poor satellite coverage in area (at the time) - this could impact ability to fly pre-programmed grids. Request Phil Rouget via email to confirm number of satellites in area. One ore carrier and MV Botnica left Milne Port heading north. MF asked Nuliajuk captain to turn off depth sounder during active surveys, as it broadcasts at 33 kHz within optimal hearing range of narwhal (potential deterrent to animals). Weather was light to moderate winds in the morning, easing off later in the day. Very little ice in area. Tested satellite phone communications. Sat phone number listed in HSE plan (+ 870 773 159791) not working reliably. Team is deferring to secondary satellite phone (+87 077 3936273) - relayed this new contact number to Mine Security and PR for daily check-in and check-outs. Established revised sched times with Mine Security (now 7 AM and 9 PM EST). No H&S incidents. AO feeling under the weather – Golder site supervisor will monitor.</p>
08-Aug-18	<p>MF/AR/SS/AO/JT - MV Nuliajuk onsite at survey location in Milne Inlet. Anchored vessel 600 m east of shipping route (72° 1.279' N, 80° 38.303' W; 85 m water depth). Bruce Head team begins surveying at 07:00. Completed 12 hourly RAD surveys. Flew UAV in survey area (pre-programmed flights and manual operations). No narwhal observed within or outside of the survey area (only seals). UAV performance continued to experience periodic GPS and compass lost communications. Testing to increase performance continued.</p> <p>One ore carrier (MV Yakutia) left Milne Port heading north. Weather was light winds (<10 knots) from variable directions with periods of winds less than 2 knots. Very little ice in area. No H&S incidents.</p> <p>MV Nuliajuk adjusted position at 21:15 approximately 150 m northeast. New anchoring position is 500 m from nominal shipping route (72° 1.332' N, 80° 38.809' W).</p> <p>Daily check-ins with Golder and Milne Port Security occurred at 07:00 and 20:30.</p>
09-Aug-18	<p>MF/AR/SS/AO/JT - MV Nuliajuk onsite at survey location in Milne Inlet. Anchored vessel 500 m east of shipping route (72° 1.332' N, 80° 38.809' W; 85 m water depth). Bruce Head team begins surveying at 07:00. Completed 12 hourly RAD surveys. Flew UAV in survey area (pre-programmed flights and manual operations). No narwhal observed within or outside of the survey area (only seals). UAV performance continued to experience periodic GPS and compass lost communications. Testing to increase performance continued. Nuliajuk shut down all</p>

2018 Bruce Head Program – DAILY UPDATES 01 August – 07 August 2018	
	<p>engines for 50 minutes @ 16:52 UTC; ships crew do not want to perform longer shutdowns due to battery drain issues. One ore carrier (MV Golden Pearl) left Milne Port heading north. Weather was light winds (<10 knots) from variable directions with periods of winds less than 2 knots. Very little ice in area. No H&S incidents. JT experienced mild sea sickness in the am but was feeling better by early afternoon – Golder site supervisor will monitor. Daily check-ins with Golder and Milne Port Security occurred at 07:00 and 20:30.</p>
10-Aug-2018	<p>MF/AR/SS/AO/JT – MV Nuliajuk onsite at survey location in Milne Inlet. Anchored vessel 500 m east of shipping route (72° 1.332' N, 80° 38.809' W; 85 m water depth). At 12:50 the Nuliajuk raised anchor and repositioned west in Koluktoo Bay (72° 03.868' N, 80° 55.879' W; 45m water depth). On site at 14:50.</p> <p>Bruce Head team begins surveying at 07:00. Completed 2 hourly RAD surveys in the morning before canceling subsequent surveys due to Force 5 winds (>17 knots) and increasing sea state to Level 4 (moderate). Visibility remained excellent throughout the day. MV Golden Bull transited north through the survey area at approximately 13:00. MV Golden Ruby transited south through the survey area at approximately 13:45.</p>
11-Aug-2018	<p>MF/AR/SS/AO/JT – MV Nuliajuk departed Koluktoo Bay at 05:30 to re-anchor near the shipping route (500m east; 72° 1.336' N, 80° 38.291' W; 90 m water depth).</p> <p>The day began with 20 kt winds and a sea state 4. By early afternoon the winds had begun to decrease. By end of day the winds were <5 kt from the north. Mostly sunny for majority of the day.</p> <p>Bruce Head team begins surveying at 07:00 and completed 12 hourly RAD surveys</p> <p>No narwhal observed in Milne Inlet or Koluktoo Bay.</p> <p>No H&S incidents.</p> <p>MV Golden Amber departed from Milne Port heading north and passed through the survey area at approximately 21:00</p>
12-Aug-2018	<p>MF/AR/SS/AO/JT – MV Nuliajuk onsite at survey location in Milne Inlet. Anchored vessel 500 m east of shipping route (72° 1.336' N, 80° 38.291' W; 90 m water depth).</p> <p>MV Golden Strength was observed heading south for Milne Port and passed through the survey area at approximately 04:00. Golden Brilliant passed through the survey area heading north at approximately 22:30.</p> <p>Bruce Head team begins surveying at 07:00 and completed 12 hourly RAD surveys.</p> <p>No narwhal observed in Milne Inlet.</p> <p>No H&S incidents.</p>

2018 BRUCE HEAD VESSEL-BASED MONITORING PROGRAM
BAFFINLAND PO #4500046008
GOLDER PROJECT 1663724-PHASE 11000

1663724
6 July 2018

2018 Bruce Head Program – DAILY UPDATES 01 August – 07 August 2018	
13-Aug-2018	MF/AR/SS/AO/JT – MV Nuliajuk onsite at survey location in Milne Inlet. Anchored vessel 500 m east of shipping route (72° 1.336' N, 80° 38.291' W; 90 m water depth). Bruce Head team begins surveying at 07:00 and completed 12 hourly RAD surveys. No narwhal observed in Milne Inlet. No H&S incidents.
14-Aug-2018	MF/AR/SS/AO/JT - MV Nuliajuk onsite at survey location in Milne Inlet. Anchored vessel 500 m east of shipping route (72° 1.336' N, 80° 38.291' W; 90 m water depth). Bruce Head team begins surveying at 05:00 and completed 11 hourly RAD surveys. MV Nuliajuk pulled up anchor at approximately 16:00 and arrived at Milne Port at 17:00. AO & JT stayed on the MV Nuliajuk and continued back to Pond Inlet. MF/AR/SS stayed in port accommodations for one night. No H&S incidents.
15-Aug-2018	AO & JT disembarked the MV Nuliajuk in Pond Inlet at approximately 06:00. MF flew to Bruce Head camp to add a solar panel to the remote AIS signal station (08:30 to 13:00). MF/AR/SS – boarded the Milne Port to Mine Site charter pass at approximately 16:00. MF/AR/SS – departed mine airstrip at approximately 20:30; destination Mirabel airport.
16-Aug-2018	MF/AR/SS – arrive at Mirabel airport at 02:30. From Mirabel airport all staff took a shuttle bus to Montreal Airport (YUL). SS flew to Toronto Airport (YYZ). MF and AR continued to Hotel Ruby Foo for overnight stay. No H&S incidents.
17-Aug-2018	MF/AR – depart Montreal (YUL) at 08:30 for Vancouver (YVR). MF continued to Powell River. AR continued to Victoria (YYJ). No H&S incidents.



golder.com

Name: Jeff W. Higdon

Agency / Organization: Qikiqtani Inuit Association

Date of Comment Submission: 12 March 2019

#	Document Name	Section Reference	Comment	Baffinland Response
1	2018 Bruce Head Vessel-Based Field Summary Report draft (file name "Bruce Head_Field Summary_Rpt-14FEB_19_DFT to MEWG.pdf")	Pg. 2-4, S. 2.1 Summary of 2014-2017 Key Findings	Some of the comments on the 2014-2017 Bruce Head report by QIA and other MEWG member agencies may be applicable to this summary and review wrt edits and updates. Does this section reflect the draft as reviewed in December 2018, or subsequent edits and revisions?	The 2018 Bruce Head vessel-based and the Bruce Head shore-based monitoring programs are distinct programs and the reporting of both programs differed. The current report is a Field Summary Report from a Pilot Program while the 2014–2017 Bruce Head Integration Report is an in-depth analysis of a multi-year program.
2	2018 Bruce Head Vessel-Based Field Summary Report draft (file name "Bruce Head_Field Summary_Rpt-14FEB_19_DFT to MEWG.pdf")	Pg. 6, S. 3.2 Training	Having the training material appended to this report is helpful, it would be beneficial to do the same with the SBO report.	Thank you for the comment. The SBO training manual has been included as an appendix in the final report.
3	2018 Bruce Head Vessel-Based Field Summary Report draft (file name "Bruce Head_Field Summary_Rpt-14FEB_19_DFT to MEWG.pdf")	Pg. 8, S. 3.4.2 UAV Operations	Is altitude data from UAV flights available to be reported?	All drone flights were performed at an altitude of 300 ft to maximize video recording spatial coverage.

#	Document Name	Section Reference	Comment	Baffinland Response
4	2018 Bruce Head Vessel-Based Field Summary Report draft (file name "Bruce Head_Field Summary_Rpt-14FEB_19_DFT to MEWG.pdf")	Pg. 9, S. 4.1 Observational Effort and Environmental Conditions (also S. 4.2 and 4.3)	Were any narwhal observed when the vessel had to relocate into Koluktoo Bay due to weather conditions (i.e., off-effort observations)? For that matter, were any off-effort observations of narwhal made? S. 4.2 would suggest none were seen at all, but S. 4.3 reports one possible sighting - was that the only one?	No confirmed or potential narwhal sightings were observed during off-effort vessel movements or when anchored in Koluktoo Bay. A single potential narwhal sighting occurred during the survey while observers were on-effort.
5	2018 Bruce Head Vessel-Based Field Summary Report draft (file name "Bruce Head_Field Summary_Rpt-14FEB_19_DFT to MEWG.pdf")	Pg. 9, S. 4.3 General Observations	<i>Pusa</i> (not <i>Phoca</i>) is generally recognized as the correct genus name for ringed seal. American researchers were the hold-outs for a few years but they have largely adopted <i>Pusa</i> now as well.	Agreed, the text has been updated accordingly.
6	2018 Bruce Head Vessel-Based Field Summary Report draft (file name "Bruce Head_Field Summary_Rpt-14FEB_19_DFT to MEWG.pdf")	Pg. 9, S. 5.0 Conclusions and Recommendations	Approximately how far did vessels deviate?	It appears that vessel tracks deviated by an approximate average of 300 m when the RV <i>Nuliajuk</i> was present.
7	2018 Bruce Head Vessel-Based Field Summary Report draft (file name "Bruce Head_Field Summary_Rpt-14FEB_19_DFT to MEWG.pdf")	Training Manual (Appendix A - Pond Inlet Inuit Training Documents), pg. 14, S. 5.6.2 Protocol (pdf pg. 33 of 100)	Footnote 4 missing (group size definition) (also page 21, footnote 12) (also no footnote 2 on pg. 14)	Thank you for the comment. The missing footnotes will be corrected in future training materials.

#	Document Name	Section Reference	Comment	Baffinland Response
8	2018 Bruce Head Vessel-Based Field Summary Report draft (file name "Bruce Head_Field Summary_Rpt-14FEB_19_DFT to MEWG.pdf")	Training Manual (Appendix A - Pond Inlet Inuit Training Documents), pg. 14, S. 5.6.2 Protocol (pdf pg. 33 of 100)	The MEWG should discuss and consider ways to increase seal data collection for monitoring when narwhal are not present/abundant (i.e., as noted, "[a]lways prioritize whale sightings").	Noted.
9	2018 Bruce Head Vessel-Based Field Summary Report draft (file name "Bruce Head_Field Summary_Rpt-14FEB_19_DFT to MEWG.pdf")	Training Manual (Appendix A - Pond Inlet Inuit Training Documents), pg. 14, S. 5.6.2 Protocol (pdf pg. 33 of 100) (also pg. 21, S. 5.7.2)	Are narwhal "herding events" defined in the training manual? QIA is unable to find a definition.	Herding event was not defined in the training manual. The definition used for a "herding event" was the same as that defined for past Bruce Head shore-based monitoring programs. Additionally, updates for the 2019 shore-based monitoring program training manual will include this definition.
10	2018 Bruce Head Vessel-Based Field Summary Report draft (file name "Bruce Head_Field Summary_Rpt-14FEB_19_DFT to MEWG.pdf")	Training Manual (Appendix A - Pond Inlet Inuit Training Documents), pg. 21, S. 5.8 Observing Techniques (pdf pg. 40 of 100)	The amount of time to be devoted to each scanning technique is provided here, but there's nothing similar in the SBO report. Were similar procedure employed there?	No defined time period was set for scanning techniques employed during the ship-based observer program. The SBO program involved continuous scanning of the water rather than collecting "snapshots" within a determined area.
11	2018 Bruce Head Vessel-Based Field Summary Report draft (file name "Bruce Head_Field Summary_Rpt-14FEB_19_DFT to MEWG.pdf")	Training Manual (Appendix A - Pond Inlet Inuit Training Documents), pg. 27, S. 5.10 Detection Cues (pdf pg. 46 of 100)	Figure 8 - caption is reversed, baleen whale blow is on the left, not right. The figures used here look like humpback whales and killer whales - images of bowhead and narwhal would be a better fit.	The caption typo is noted. Thank you. The training materials are primarily intended to teach Inuit observers survey protocols. The photos are used to guide the discussion. It is recognized that community observers are very familiar with the local species and environment.

#	Document Name	Section Reference	Comment	Baffinland Response
				Updates to training manuals for future years can be revisited to include images of bowhead and narwhals.
12	2018 Bruce Head Vessel-Based Field Summary Report draft (file name "Bruce Head_Field Summary_Rpt-14FEB_19_DFT to MEWG.pdf")	Training Manual (Appendix B - Species Identification), pg. 2 (pdf pg. 76 of 100)	The manual states that "killer whales will be the only whale you may see with a prominent dorsal fin." This is not necessarily the case, as there have been minke whales seen in the area (one was killed by Pond Inlet hunters a couple years ago in fact), and there have also been credible reports of dolphins. Sperm whales are also present and have a dorsal fin, albeit much more distinctive-looking than minke whales or dolphins. Telling observer trainees that the only whale they might see with a dorsal fin are killer whales potentially biases observations.	Agreed that other whale species have dorsal fins, but we do not consider them to be as "prominent" as it is the case for killer whales. Also, see response to IR# 11.
13	2018 Bruce Head Vessel-Based Field Summary Report draft (file name "Bruce Head_Field Summary_Rpt-14FEB_19_DFT to MEWG.pdf")	Training Manual (Appendix B - Species Identification)	A better (more thorough) selection of photos showing key identification characteristics of the various species, and other species that may occur, would likely improve observer training.	See response to IR# 11.

#	Document Name	Section Reference	Comment	Baffinland Response
14	2018 Bruce Head Vessel-Based Field Summary Report draft (file name "Bruce Head_Field Summary_Rpt-14FEB_19_DFT to MEWG.pdf")	Training Manual (Appendix B - Species Identification), pg. 3 (pdf pg. 77 of 100)	"Adult" harp seals are distinguishable from ringed seals due to the saddle patch, not all harp seals. The majority of harp seals seen in the area will likely be adults, but juvenile seals ("bedlamers") will be present as well. Their pelage is silvery in colour with black spots on the back, as noted in the manual, and these juvenile harp seals will be harder to distinguish from ringed seals (and likely explain the questionable group sizes reported in the SBO draft report). The descriptions of the various pinnipeds should be updated to reflect the variation in pelage patterns and focus on key identification features.	See response to IR# 11.
15	2018 Bruce Head Vessel-Based Field Summary Report draft (file name "Bruce Head_Field Summary_Rpt-14FEB_19_DFT to MEWG.pdf")	Training Manual (Appendix B - Species Identification), pg. 4 (pdf pg. 78 of 100)	Walrus are distinctive, yes, but a photo would still be beneficial. They can be confused with bearded seals depending on sighting quality (e.g., what parts of the animal are visible), and the manual should highlight differences between the species in water, using a series of photos.	See response to IR# 11.

Name: Laura Watkinson

Agency / Organization: DFO Science

Date of Comment Submission: April 3, 2019

#	Document Name	Section Reference	Comment	Baffinland Response
1	2018 Bruce Head Vessel-Based Field Summary Report draft (file name "Bruce Head_Field Summary_Rpt-14FEB_19_DFT to MEWG.pdf")	N/A	There is a large gap in observations between the ice-management observations and the 8-day open water observations. A more complete time series of observations would be more useful for comparison.	The Bruce Head Vessel-based Monitoring Program was a pilot study and was not intended to cover periods when ice was present in the study area. It would have been unsafe to anchor this research vessel in waters with moving ice.
2	2018 Bruce Head Vessel-Based Field Summary Report draft (file name "Bruce Head_Field Summary_Rpt-14FEB_19_DFT to MEWG.pdf")	N/A	It would be important to indicate in the report if the engine of the Nuliajak was shut off throughout the observation period while it was anchored.	All of the ship's engines, including the generator, were only shut down for a one-hour period during the entire survey. The ship's crew felt that running the vessel without generated power was not a safe practice.
3	2018 Bruce Head Vessel-Based Field Summary Report draft (file name "Bruce Head_Field Summary_Rpt-14FEB_19_DFT to MEWG.pdf")	N/A	There is concern that no narwhal were observed during the 8-day observation period and the report does not provide any suggestions as to why that may be in this case. DFO Science suggests that the report analyze the data from 2014-2017(just in that small area) to make a comparison to 2018, this may be useful to further describe the change. As it is currently presented, the fact that the observers were not seeing Narwhal in the area is difficult to interpret when their methodology from 2017 to 2018 completely changed	<p>The difference in data collection methodology and survey area does not allow for data comparison between programs. The 2018 vessel-based monitoring program was set up as a pilot study. Collecting data that would enable a direct comparison to previous Bruce Head shore-based monitoring programs was not the intent of this study.</p> <p>The Bruce Head shore-based monitoring program will resume</p>

#	Document Name	Section Reference	Comment	Baffinland Response
			<p>and they only have monitoring for 8 days of the entire shipping season. The methods associated with the shore based program that was in place from 2014-2017 should be implemented in future monitoring. Had this been in place in 2018 a direct comparison would have been possible, and would have helped to provide insight into the fact that the overall Narwhal abundance throughout the summer was lower in 2018. In order to maintain comparison across years, the original monitoring methods should be implemented in future years (e.g., shore-based program).</p>	<p>in 2019, allowing comparable methodologies to previous years.</p>
7	<p>2018 Bruce Head Vessel-Based Field Summary Report draft (file name "Bruce Head_Field Summary_Rpt-14FEB_19_DFT to MEWG.pdf")</p>	N/A	<p>"The Proponent shall conduct a monitoring program to confirm the predictions in the FEIS with respect to disturbance effects from ships noise on the distribution and occurrence of marine mammals. The survey shall be designed to address effects during the shipping seasons, and include locations in Hudson Strait and Foxe Basin, Milne Inlet, Eclipse Sound and Pond Inlet. The survey shall continue over a sufficiently lengthy period to determine the extent to which habituation occurs for narwhal, beluga, bowhead and walrus." There is a concern that the limited season (August 7-14) does not meet requirements for the survey to be over a "lengthy period". Moving forward into Phase 2 of the Project, monitoring should occur over the entire shipping season in order to monitor the effects of shipping effectively</p>	<p>The monitoring program includes multiple components that collectively satisfy the Project Conditions. In addition to the Bruce Head vessel-based or shore-based monitoring programs, the narwhal tagging program, the ship-based observer program, the acoustic monitoring program and aerial surveys are all components of the marine mammal monitoring program.</p> <p>The Bruce Head shore-based monitoring program covers periods when observers can safely access the site (i.e. helicopter support is available and drinking water is available).</p> <p>The Bruce Head shore-based monitoring program will resume in 2019, allowing comparable methodologies to previous years.</p>

#	Document Name	Section Reference	Comment	Baffinland Response
			over the entire season including the shoulder season.	
8	2018 Bruce Head Vessel-Based Field Summary Report draft (file name "Bruce Head_Field Summary_Rpt-14FEB_19_DFT to MEWG.pdf")	N/A	Late arrival does not cover the period during which ice-breaking took place (July).	The Bruce Head Vessel-based Monitoring Program was a pilot study and not intended to cover periods when ice was present in the study area. It would have been unsafe to anchor this research vessel in waters with moving ice.
4	2018 Bruce Head Vessel-Based Field Summary Report draft (file name "Bruce Head_Field Summary_Rpt-14FEB_19_DFT to MEWG.pdf")	N/A	"Vessel disturbance may induce several different behavioural responses, including a shift in swim speed or dive rate, fleeing, freeze response, avoidance or displacement... Low sightings rates of Narwhal recorded during vessel based surveys undertaken in areas known to support high densities of Narwhal suggests that animals may actively avoid or be displaced by vessels." (see also pg. 14 Golder, 2017 Narwhal Tagging Study draft for MEWG). The observer program was conducted upon a vessel of 18m, much smaller than the vessels analyzed in the 2017 Narwhal Tagging Study (Page 23. vessel of 100m or greater for analysis) therefore, it is difficult to say how much disturbance or avoidance to expect from this smaller observer vessel.	Agreed. The 2018 vessel-based pilot study was designed as a study examining changes in relative abundance and distribution. Therefore, the intent was not to evaluate potential effects to narwhals from research vessel's activity.
5	2018 Bruce Head Vessel-Based Field Summary Report draft (file name "Bruce Head_Field Summary_Rpt-14FEB_19_DFT to MEWG.pdf")	N/A	Bruce Head Survey is in its 6 th season, yet results only show data from 2018. No trends shown are shown in the report. We recognize that 2018 had different methods, but study design should have accounted for this and been able to standardize effort (e.g., 0 sightings over 176 hours in 2018 = 0 Narwhal/hour; compared to 2014	The Bruce Head Vessel-based Monitoring Program was proposed as a pilot study intended to assess a different methodology to collect data on the impact of vessel traffic on narwhal. The intent is not to compare it with data collected in previous years from the Bruce

#	Document Name	Section Reference	Comment	Baffinland Response
			<p>of 110.2 Narwhal/hour, 2015 of 84.2 Narwhal/hour, 2016 of 156.4 Narwhal/hour, 2017 of 115.3 Narwhal/hour). Results show that no Narwhal were seen during the monitoring program year, yet there is no discussion regarding the lack of Narwhal or mention of Baffinland's thresholds for significant impacts.</p>	<p>Head shore-based monitoring program.</p> <p>Early warning indicators and corresponding thresholds are currently being developed, in collaboration with the Marine Environmental Working Group (MEWG). Once these thresholds are established, results of monitoring programs will be assessed in relation to them.</p>
6	<p>2018 Bruce Head Vessel-Based Field Summary Report draft (file name "Bruce Head_Field Summary_Rpt-14FEB_19_DFT to MEWG.pdf")</p>	N/A	<p>An important component of any monitoring program is comparison of baseline data, to the data collected for the Early Revenue Phase, as well as changes/impacts from the increase of 4.2 Mtpa to 6.0 Mtpa (2018). The comparison of data collected prior to 2018 with that collected in 2018 is important for determining impact.</p>	<p>As discussed in MEWG meetings, the Bruce Head shore-based observation station was not available in 2018 because the platform was blown off the site in fall 2017. As part of Baffinland's core safety values and associated procedures, an internal Baffinland safety audit was required to ensure safety for any future work at this site. This audit was completed during 2018 and thus prevented the shore-based program from occurring in 2018 and, therefore, any direct comparison of data collected during previous monitoring seasons at Bruce Head.</p> <p>The Bruce Head shore-based monitoring program will resume in 2019, allowing comparable methodologies to previous years.</p> <p>Additional relevant information is also provided in response to Information Request #5.</p>

Name: Parks Canada – Protected Areas Establishment and Conservation Branch (via Chantal Vis)

Agency / Organization: Parks Canada

Date of Comment Submission: March 11, 2019

#	Document Name	Section Reference	Comment	Baffinland Response
1	<i>2018 Bruce Head report</i>	4.2	<p>In 2018, the Bruce Head ship based observer program reported zero narwhal observations, but provides no trends to previous years or explanations.</p> <p>As this program was designed to be a replacement for the Bruce Head Monitoring Program, some comparison using standardized effort or area should be available.</p>	<p>The 2018 Bruce Head Vessel-based Monitoring Program was proposed as a pilot study intended to assess a different methodology to collect data on the impact of vessel traffic on narwhal. The intent is not to compare it directly with data collected in previous years from the Bruce Head shore-based monitoring program.</p>
2	<i>2018 Bruce Head report</i>	5.0	<p>Zero narwhal observed over the August 7th -14th period suggests a large change in abundance and/or distribution. Baffinland provides no discussion based on the results, nor do they link the results back to the thresholds that they are monitoring against.</p> <p>All reports moving forwards should re-state the threshold that Baffinland has established for disturbance (FEIS, 2013) and results should be link back to these disturbance thresholds.</p>	<p>See response to IR #1.</p> <p>Early warning indicators and corresponding thresholds are currently being developed, in collaboration with the MEWG. Once these thresholds are established, results of monitoring programs will be assessed in relation to them.</p>

#	Document Name	Section Reference	Comment	Baffinland Response
3	<i>2018 Bruce Head report</i>	3.4	<p>The period of August 7th to 14th does not satisfy the requirement set by Condition 109 to shall conduct a monitoring program...(that) shall be designed to address effects during the shipping seasons.... The survey shall continue over a sufficiently lengthy period to determine the extent to which habituation occurs for narwhal, beluga, bowhead and walrus.</p> <p>This monitoring period does not cover the times when Baffinland was using an Icebreaker during the 2018 season.</p> <p>Moving forwards observational programs like Bruce Head need to cover the entire shipping period, including the shoulder season.</p>	<p>The monitoring program includes multiple components that collectively satisfy the Project Conditions. In addition to the Bruce Head vessel-based or shore-based monitoring programs, the narwhal tagging program, the ship-based observer program, the acoustic monitoring program and aerial surveys are all components of the marine mammal monitoring program.</p> <p>The Bruce Head shore-based monitoring program covers periods when observers can safely access the site (i.e. helicopter support is available and drinking water is available).</p>
4	<i>2018 Bruce Head report</i>	3.4.1	<p>Monitoring program occurred on a vessel, a known disturbance to narwhal, “low sightings rates of narwhal recorded during vessel based surveys undertaken in areas known to support high densities of narwhal suggests that animals may actively avoid or be displaced by vessels” (Golder, 2017 Narwhal Tagging Study draft for MEWG pg. 14).</p> <p>Recommendation to return to shore based monitoring at Bruce Head using comparable methodologies to previous years.</p>	<p>The Bruce Head shore-based monitoring program will resume in 2019, allowing comparable methodologies to previous years.</p>

#	Document Name	Section Reference	Comment	Baffinland Response
5	2018 Bruce Head report	4.2	Baffinland has not demonstrated that an increase in shipping from 4.2MTA in 2017 to 6.0MTA in 2018 with the use of an Icebreaker, has not had significant impacts to narwhal's abundance and/or distribution within the LSA.	No response required with regards to the 2018 Bruce Head Vessel-based Monitoring Program Report.
6	2018 Bruce Head Report	4.3	Despite the general absence of narwhals, the vessel did not observe the behavior of seals in the area using either personal or UAV observation methods. It is unclear whether any notes were taken regarding the responses of other marine mammals.	Seal behaviour was not recorded as they were not the target species of this monitoring program.
7	2018 Bruce Head Report	3.3	It is unclear in the report why this location for the vessel was selected to monitor narwhals in the 2018 season. Observational success based on proximity to the shipping lane would have been lessened as it was noted that project vessels deviated from the track when the monitoring vessel was present.	<p>The RV <i>Nuliajuk</i> was limited by the depth of water it could safely anchor in (~100 m or less). The selected location was the best compromise for shallow bathymetry, proximity to higher narwhal density (derived from 2017 tagging data) and proximity to the shipping route. There was no suitable anchorage in the vicinity of Bruce Head. Avoiding interference with Inuit hunting and vessel safety were also factors considered in the selection of the vessel anchorage location.</p> <p>The intent of the research program was not to have vessels deviate from the shipping route. This was communicated to project vessels prior to the start of the shipping season. Ultimately, vessel captains are responsible for the safety of their vessels and ore carriers appeared to</p>

#	Document Name	Section Reference	Comment	Baffinland Response
				deviate away from the <i>Nuliajuk</i> due to perceived safety risks.